

INTEX® OWNER'S MANUAL

Quick-Fill™ Electric Air Pump

Model AP636 12V 8A

18PO

READ AND FOLLOW ALL INSTRUCTIONS BEFORE USING THIS PRODUCT

WARNING

- Adult use only.
- Household use only.
- Do not drop unit into water or expose unit to rain or water.
- Do not direct air stream at face or body.
- Do not operate for more than 15 minutes at a time. Unplug and let cool at least 5 minutes.
- Unplug unit when not in use.
- Do not obstruct vent holes or open source.
- Do not insert objects into the inflation or deflation connector.
- The DC supply cord cannot be replaced. If the cord is damaged the appliance should be scrapped.
- To reduce the risk of electric shock, do not expose to rain. Store indoors.
- This appliance is not intended for use by persons (including children) with reduced physical, sensory or mental capabilities, or lack of experience and knowledge, unless they have been given supervision or instruction concerning use of the appliance by a person responsible for their safety.
- Children should be supervised to ensure that they do not play with the appliance.

FOLLOW THESE RULES AND ALL INSTRUCTIONS TO AVOID PROPERTY DAMAGE, ELECTRIC SHOCK, BURNS OR OTHER INJURY.

CAUTION

- To reduce the risk of electric shock, do not expose to rain. Store indoors.

NAMES OF PARTS

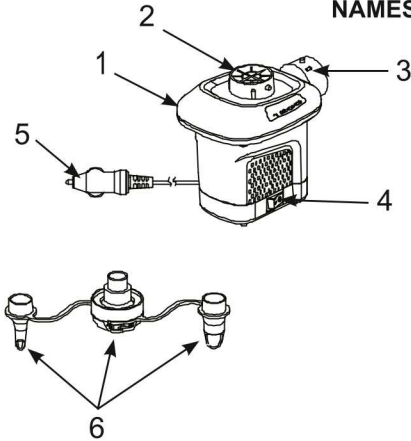

PARTS DESCRIPTION:

1. PUMP
2. DEFLATION CONNECTOR
3. INFLATION CONNECTOR
4. SWITCH
5. DC CIGARETTE CORD
6. NOZZLES
7. VENT HOLES / SLOTS

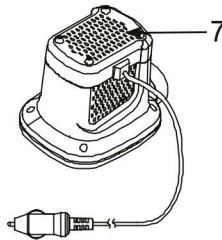

NOTE: Drawings for illustration purpose only. May not reflect actual product. Not to scale.

OPERATING INSTRUCTIONS

INFLATION

1. Attach nozzle to the inflation connector if necessary and hold pump against inflation valve on item to be inflated. See Fig (1).

READ AND SAVE THESE INSTRUCTIONS

OPERATING INSTRUCTIONS

NOTE: On large items like inflatable boats and large air mattresses, the pump will fit directly into the inflation valves and provide faster inflation times. Use the appropriate nozzle on small inflation valves as on small air mattresses, etc.

2. Plug in the DC line cord into a car cigarette lighter outlet. See Fig (2).
3. SWITCH ON: Press "I"; SWITCH OFF: Press "O". See Fig (3).

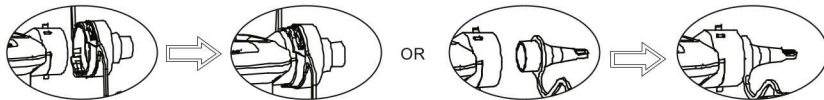

FIG (1): ATTACH NOZZLE

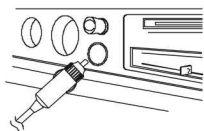

FIG (2)

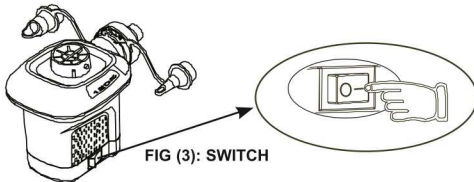

FIG (3): SWITCH

DEFLATION

1. Attach nozzle to the deflation connector if necessary and hold pump against inflation valve on item to be deflated. See Fig (4).

NOTE: On large items like inflatable boats and large air mattresses, the pump will fit directly into the inflation valves and provide faster deflation times. Use the appropriate nozzle on small inflation valves as on small air mattresses, etc.

2. Plug in the DC line cord into a car cigarette lighter outlet. See Fig (2).
3. SWITCH ON: Press "I"; SWITCH OFF: Press "O". See Fig (3).

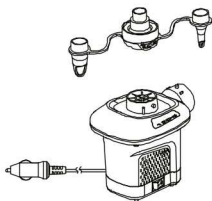

FIG (4): ATTACH NOZZLE

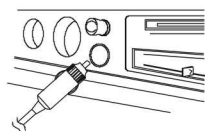

FIG (2)

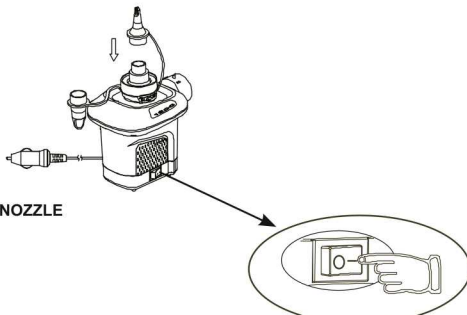

FIG (3): SWITCH

MAINTENANCE INSTRUCTIONS

No specific air pump maintenance is required. Air pump has no user serviceable parts.

MOVING AND STORAGE INSTRUCTIONS

Move the product, air pump and accessories to the power source location. Make sure the power cord is free of twist, kink and knot. Fold the power cord loosely, and return pump and nozzles to package when not in use.

©2021 Intex Marketing Ltd. - Intex Development Co. Ltd. - Intex Recreation Corp. All rights reserved/Tous droits réservés/Todos los derechos reservados/Alle Rechte vorbehalten. Printed in China/Imprimé en Chine/Impreso en China/Gedruckt in China.
 ®™ Trademarks used in some countries of the world under license from®™ Marques utilisées dans certains pays sous licence de/Marcas registradas utilizadas en algunos países del mundo bajo licencia de/Warenzeichen verwendet in einigen Ländern der Welt in Lizenz von/Intex Marketing Ltd. to/à/an Intex Development Co. Ltd., G.P.O Box 28829, Hong Kong & Intex Recreation Corp., P.O. Box 1440, Long Beach, CA 90801 • Distributed in the European Union by/ Distribué dans l'Union Européenne par/Distribuido en la Unión Europea por/Vertrieb in der Europäischen Union durch/Intex Trading B.V., Venneveld 9, 4705 RR Roosendaal – The Netherlands
 www.intexcorp.com

INTEX®

READ AND SAVE THESE INSTRUCTIONS