



MEMBER

PRODUCT MEETS  
INDUSTRY STANDARDS  
RECOGNIZED BY TMA



GAME WINNER™

# Instruction Manual

## DOUBLE UP 2 MAN LADDER STAND

ITEM:163790

**CAUTION**-Never have more than one person on the ladder at a time. Maximum weight capacity on ladder is 300 pounds.



**Maximum Weight Capacity (User and Equipment)- 500 pounds (226 kg)**



### ATTENTION

**YOU MUST READ ALL WRITTEN INSTRUCTIONS AND WATCH THIS SAFETY VIDEO BEFORE USING!**



**WATCH THIS SAFETY VIDEO BEFORE USING!**

Scan →



or Visit →

[www.standsafety.com/in3](http://www.standsafety.com/in3)

Scan the QR code with your smart phone, tablet or similar device.

OR

Type the website address into your web browser to view an important safety video before using this product.

**LADDER STAND SAFETY**

**Every year people are injured from hunting related falls. Most of these injuries could have been prevented by following the instructions and warnings provided with the treestand and safety harness. Tree stands are used at height and falls can result in serious injury or death. Your own safety, and the safety of any user of this product, should be your first priority. In order to reduce your risk of injury, you MUST read and thoroughly understand all of the safety warnings, usage instructions and other information contained within the written and safety video instructions and warnings provided with this product, and any other hunting equipment used. Retain the instructional and warning materials and review them periodically (at least once a year and always with any new user). Failure to follow all instructions and warnings may lead to serious injury or death. DO NOT USE THIS PRODUCT UNTIL AND UNLESS YOU HAVE READ AND THOROUGHLY UNDERSTAND ALL INSTRUCTIONS, SAFETY WARNINGS AND OTHER MATERIALS. If you have any questions, do not use the product until you have contacted the manufacturer at 949-262-3416 or email [customerservice@innopower.biz](mailto:customerservice@innopower.biz).**

### Business Hours:

Monday through Friday, 8:00 am to 5:00 pm ET. If you are unable to speak with a representative, please leave a voicemail with your contact information and your call will be returned within one (1) business day.

For Customer Service, please call 949-262-3416 or

E-mail: [customerservice@innopower.biz](mailto:customerservice@innopower.biz)



(Made In China)


Warnings .....	3-7
Tools Required .....	7
Parts List .....	8-12
Hardware .....	13-14
Product Diagram .....	15
Assembly Instructions .....	16-23
Installation Instructions .....	24-30
Usage .....	31-32
Removal Instructions .....	33
Care and Maintenance .....	34
Warranty Information .....	35


Note: Before beginning assembly of product, make sure all parts are present. Compare parts with package content list and hardware contents. If any part is missing or damaged do not attempt to assemble the unit. Contact customer service for replacement parts.


# Warnings


## ATTENTION !


 WHEN YOU SEE A  SYMBOL OR THE WORD "WARNING!" BE SURE TO READ THE MESSAGE! THE INFORMATION CONTAINED IN THESE MESSAGES CAN SAVE YOUR LIFE OR PREVENT SERIOUS INJURY!! BE SAFE! FOLLOW ALL WARNINGS!!


 WARNING! FALLS FROM A TREESTAND CAN OCCUR ANYTIME AFTER LEAVING THE GROUND. THESE FALLS RESULT IN EITHER SERIOUS INJURY OR DEATH! FOR YOUR PERSONAL SAFETY, PLEASE TAKE A MOMENT TO CAREFULLY READ THIS PRODUCT INSTRUCTION MANUAL IN ITS ENTIRETY BEFORE ATTEMPTING TO ASSEMBLE, SET-UP, INSTALL AND/OR OTHERWISE USE THIS GAME WINNER PRODUCT. ANNUALLY REVIEW THE CONTENTS OF THIS INSTRUCTION MANUAL. ADDITIONALLY, KEEP THESE INSTRUCTIONS FOR THE ENTIRE DURATION YOU OWN THIS PRODUCT(S). FAILURE TO FOLLOW THESE INSTRUCTIONS MAY RESULT IN SERIOUS INJURY OR DEATH!


 WARNING! THE SAFE USE AND OPERATION OF THIS PRODUCT(S) IS THE SOLE RESPONSIBILITY OF THE USER. IT IS THE SOLE RESPONSIBILITY OF THE OWNER TO PROVIDE ANY PERSON(S) WHO BORROW OR PURCHASE THIS PRODUCT WITH ALL WRITTEN AND SAFETY VIDEO INSTRUCTIONS AND WARNINGS PRIOR TO USE. DO NOT ALLOW A PERSON TO USE THE PRODUCT THAT HAS NOT REVIEWED ALL WRITTEN AND SAFETY VIDEO INSTRUCTIONS AND WARNINGS PRIOR TO USE. FAILURE TO FOLLOW THESE INSTRUCTIONS MAY RESULT IN SERIOUS INJURY OR DEATH! STORE ALL WRITTEN AND SAFETY VIDEO INSTRUCTIONS AND WARNINGS IN A SAFE LOCATION WHERE THEY CAN BE SHARED WITH POTENTIAL USERS. IF ANY INSTRUCTIONS OR WARNINGS ARE LOST OR DISCARDED, DO NOT USE THE PRODUCT AND DO NOT ALLOW ANY OTHER PERSON TO USE THE PRODUCT.


 WARNING! THIS PRODUCT CARRIES A STRICT WEIGHT LIMITATION. DO NOT USE THIS PRODUCT IF YOU EXCEED THIS TOTAL WEIGHT LIMIT. PLEASE NOTE THIS WEIGHT LIMIT INCLUDES THE USER AND EQUIPMENT. FAILURE TO FOLLOW THESE INSTRUCTIONS MAY RESULT IN SERIOUS INJURY OR DEATH!

 WARNING! Prior to each hunt, make certain you have a signaling device (e.g., mobile phone, cell phone, radio, whistle, signal flare, Personal Locator Device [PLD], etc.) in your possession and on your person in an operable condition. This device must be within easy access should you experience the need to contact emergency assistance. Failure to follow this instruction may result in serious injury or death!










 WARNING! Thoroughly inspect this or any other Game Winner product(s) prior to use for signs of wear, rot, corrosion, cracks, fraying, deterioration and/or any other type of damage. DO NOT use this or any other Game Winner product(s) if they show evidence of wear, rot, corrosion, cracks, fraying, deterioration and/or any other type of damage. Failure to follow these instructions may result serious injury or death!

 WARNING! Do not remove, modify any portion or otherwise mechanically modify this product or its assemblies in any manner. Make certain that all parts are used in the assembly of this product. Parts are designed and tested to work together. Modification, additions, misuse, part omission or substitution shall immediately void your factory warranty and may result in serious injury or death! If you suspect a part(s) is missing and/or damaged, immediately contact Innopower Inc. at (949) 262-3416 for replacement of missing or defective parts. Never modify your stand in any way by making repairs, altering, omitting, adding or attaching anything to it. ALWAYS USE GENUINE FACTORY AUTHORIZED INNOPOWER INC. REPLACEMENT PARTS. USE OF ANY REPLACEMENT PARTS OTHER THAN GENUINE INNOPOWER INC. PARTS VOIDS YOUR WARRANTY AND RELIEVES INNOPOWER INC. OF ANY RESULTANT LIABILITIES AND MAY RESULT IN SERIOUS INJURY OR DEATH!













 WARNING! This product is designed for adult use only. No one under the age of 18 should attempt to use this product or any other Game Winner product(s) without direct adult supervision.

 WARNING! Prior to attempting to use this or any Game Winner product(s), you must take a moment and become familiar with its assembly, setup, installation and removal. You must practice setting-up using and removing the product(s) at ground level prior to attempting to use it at heights above ground-level. Once you have become thoroughly knowledgeable and comfortable with this products set-up, use and removal at ground-level, you are now ready to use it at heights above ground-level. Failure to follow these instructions may result in serious injury or death!

# Warnings









-  **WARNING!** When hunting from a treestand falls can occur any time after leaving the ground causing injury or death. Always wear your full-body fall arrest system (FAS) comprising a full-body harness, tether, tree belt and Suspension Relief Device at all times after leaving the ground. When using a ladder stand, you must connect to the tree as soon as possible and prior to stepping on the platform of the treestand. Please read and review your full body harness instructions and the safety video for instruction of the safe use of harnesses when using a ladder treestand. Single safety belts and chest harnesses are no longer allowed and should never be used as they put the user at serious risk of injury or death. If you are not wearing your full-body arrest harness properly attached to the tree that is protecting you from a fall, do not leave the ground. Failure to follow these instructions may result in serious injury or death!
-  **WARNING!** Never rely on a tree branch for support while climbing. Failure to follow these instructions may result in serious injury or death!
-  **WARNING!** You must always inform someone of your hunting location, where the treestand will be located and the expected duration of the hunt. Failure to follow these instructions may result in serious injury or death!
-  **WARNING!** Inspect all safety devices each time before each use. DO NOT leave ground or use these devices if they show signs of wear, damage, deterioration, vandalism, fraying or other damage. Factors such as tree growth, vandals, weather and animals may affect the performance of an unattended treestand or safety device. Do not store these devices outdoors when not in use. Failure to follow these instructions may result in serious injury or death!
-  **WARNING!** Practice using your full-body fall arrest harness at ground-level in the presence of a responsible adult to experience the feeling of hanging suspended before using in a hunting environment. Failure to follow these instructions may result in serious injury or death!
-  **WARNING!** The length of the full-body fall arrest tether must be minimized at all times. It should be adjusted so that it is above the head with no slack (snug) in the sitting position and you should have the minimum amount of slack possible when climbing. Failure to follow these instructions may result in serious injury or death!
-  **WARNING!** Never attempt to climb up or climb down with a weapon and/or gear period. ALWAYS unload your weapon and pull it up to hunting height using pull up rope when raising or lowering firearms, the chamber must be open and the barrel pointing toward the ground. ALWAYS lower your unloaded weapon down to the ground prior to attempting to climb down. Use this same method when raising or lowering all other gear. Failure to follow these instructions may result in serious injury or death!
-  **WARNING!** Failure to follow harness instructions could result in not being able to return to the stand and being suspended in a harness after a fall. If your hunting location is unknown by anyone and communications efforts are unsuccessful, you must have a personal plan for self-recovery/escape should you experience a fall. Prolonged suspension in a harness can be fatal. It is important to exercise the legs by pushing against the tree or doing other forms of continuous leg exercise to avoid blood pooling while being suspended. Varying degrees of physical fitness may require different plans for self-recovery/escape to avoid the effects of prolonged suspension. Have a personal plan and practice it in the presence of a responsible adult before leaving the ground. No one escape/rescue plan will work for every hunter, on every tree, in every circumstance. Only you can determine the best self-recovery/escape plan for your hunting situation and you must have a self-recovery/escape plan for your individual situation before leaving the ground. There is time to make a correct decision on what action to take if a fall occurs while wearing a full-body fall arrest harness. It is important to remember, "DO NOT PANIC." You must only hunt from the ground when self-recovery/escape ability is absent. Failure to follow these instructions may result in serious injury or death!  
Several optional products/systems are available that offer self-recovery or self extraction from a fall when suspended in a harness. Some systems automatically descend the user while others allow user control. One of these products/systems can be considered for use as an additional safety precaution against prolonged suspension and suspension trauma. Be sure to follow the manufacturers' directions on the safe use of these products/systems.
-  **WARNING!** A suspension relief device must be on your person and readily accessible while using your full-body fall arrest harness. These devices allow the user to relieve the load on the lower extremities if suspended in a harness and help maintain circulation in the legs, mitigate suspension trauma (blood pooling) or allow descent to the ground. Be sure to follow the directions on the safe use of any suspension relief device. Failure to follow these instructions may result in serious injury or death!

# Warnings

-  **WARNING!** If you have a limiting physical and/or health condition, **DO NOT** hunt from heights above ground level. Hunt from the ground when self-recovery/escape ability is absent. Failure to follow these instructions may result in serious injury or death!
-  **WARNING!** **NEVER** allow the harness tether to get under your chin or around your neck. This poses a choking hazard that can lead to serious injury or death. Failure to follow these instructions may result in serious injury or death!
-  **WARNING!** **DO NOT** attempt to use this and/or any other Game Winner product(s) when ice, snow and/or freezing rain has deposited or formed on any portion of the tree you intend to climb. Failure to follow these instructions may result in serious injury or death!
-  **WARNING!** **ALWAYS** maintain three (3) point contact when climbing up/down when using this product. Proper three (3) point contact means having either two (2) feet with one (1) hand on step or one (1) foot with two (2) hands on the step portion of the climbing aids at all time when climbing up or down. Failure to follow these instructions may result in serious injury or death!
-  **WARNING!** **NEVER** adjust any straps, cables, and/or adjustable support bars while standing on treestand. Make all adjustments at ground level. **DO NOT** use any treestand if there is wear, rot, corrosion, cracks, fraying, deterioration and/or any other type of damage on any part of the treestand. Failure to follow these instructions may result in serious injury or death!
-  **WARNING!** **DO NOT** modify, fix/repair, alter, bend, cut, weld, or heat this product in any way. Failure to follow these instructions may result in serious injury or death!
-  **WARNING!** **DO NOT** lean out from a treestand for any reason. Never use your full-body arrest harness to help you lean out from your treestand to make a difficult shot. Failure to follow these instructions may result in serious injury or death!
-  **WARNING!** **DO NOT** use this product or attempt to use this product on a dead, leaning, diseased, loose barked tree (bark that flakes or falls off), irregular shaped trees or utility poles. **DO NOT** use this product on any tree that does not allow for a level standing platform. Failure to follow these instructions may result in serious injury or death!
-  **WARNING!** Never jump or bounce on a treestand for any reason. Failure to follow these instructions may result in serious injury or death!
-  **WARNING!** Never leave a treestand in a tree for more than two (2) weeks (14 days). Weather, elements, animals, vandalism, and/or other mechanisms could damage the treestand. Tree growth can also stress and damage straps, chains and buckles. Failure to follow these instructions may result in serious injury or death!
-  **WARNING!** **DO NOT** use this or any other Game Winner product(s) if you have a history of heart problems, back problems, impaired vision, joints that lock-up, spinal fusions, equilibrium problems, high blood pressure, are not well-rested and/or any other physical impairment that may limit your ability to use and/or operate this product(s) in the safe manner outlined in this instruction manual. Additionally, do not use this or any other Game Winner product(s) if you are currently taking any medication (including prescription or over-the-counter [OTC]) and/or using and/or consuming any substance, or consumed any substance, including alcohol, that may limit your ability to use this product as outlined and described in this instruction manual. Never use a treestand when feeling ill, nauseous or dizzy. Do not use any Game Winner product(s) without consent from your medical doctor. Failure to follow these instructions may result in serious injury or death!
-  **WARNING!** **DO NOT** attempt to use this or any other Game Winner product(s) when lightning or thunderstorms are threatening and/or present within five (5) miles. Do not attempt to use this or any other Game Winner product(s) during or under threat of any adverse weather condition. This includes weather conditions which have the potential for producing winds, lightning, rain, snow, sleet and/or any other atmospheric condition which may limit the user's ability to operate this product in a safe manner as described in this instruction manual. Should inclement weather conditions arise during your use of this product, return to the ground immediately. Failure to follow these instructions may result in serious injury or death!

# Warnings

## SPECIAL CONSIDERATIONS FOR LADDER TREESTAND USAGE

-  **WARNING!** You must use at least three (3) adults to install and/or take down this ladder treestand. Failure to follow these instructions may result in serious injury or death!
-  **WARNING!** You must install and attach the crisscross straps and the described stabilization devices as described in this manual prior to attempting to climb this treestand. These devices add necessary balance and support for the complete climbing system. Failure to properly use and attach those items, and to follow these instructions may result in serious injury or death!
-  **WARNING!** When installing this ladder treestand you must bounce on the first rung to set the ladder into the ground prior to attempting to climb any higher. Failure to follow these instructions may result in serious injury or death!
-  **WARNING!** You must check every ladder section connection every time you use the stand before you leave the ground. The sections should be connected securely using the provided u-brackets and bolts which add support and ensure proper connection. If you find that the ladder sections are separating, or if any of the u-brackets or bolts are not properly attached, **DO NOT USE** the treestand. Failure to follow these instructions may result in serious injury or death!
-  **WARNING!** You must check the ground under the treestand to make sure it is firm and level. Sloping ground or uneven surfaces (e.g., one foot on a rock) can cause your ladder to tilt or shift off the tree as you climb. Failure to follow these instructions may result in serious injury or death!
-  **WARNING!** You must maintain three (3) points-of-contact when climbing the ladder (i.e., two feet-one hand, two hands-one foot). Failure to follow these instructions may result in serious injury or death!
-  **WARNING!** You must always lean forward as you climb and attach your full-body fall arrest harness to the tree before securing the platform to the tree and stepping onto the standing platform. Failure to follow these instructions may result in serious injury or death!
-  **WARNING!** Always have a second adult present or at least accessible by cell phone or other means when using this product. The ability to get help quickly may save your life in the event of a fall. A good non-slip safety boot is important for your safety. Be especially careful that bootlaces do not get hooked on the pod stand (tuck shoelaces into boot before climbing). Failure to follow these instructions may result in serious injury or death!

# Warnings

## FULL-BODY FALL ARREST HARNESS SYSTEM (FAS)

Two (2) full-body fall arrest harnesses have been included with this product for your use. These full-body fall arrest harnesses have been designed to keep you from experiencing a fall. Remember, the most important part of your hunt is returning home to your family safe and sound.

**READ THE FULL-BODY FALL ARREST HARNESS MANUAL CAREFULLY AND FOLLOW ALL THE INSTRUCTIONS! YOUR NEW FULL-BODY FALL ARREST HARNESS IS DESIGNED FOR A MAXIMUM CAPACITY OF 300 POUNDS (136kg). ADDITIONALLY-YOUR NEW FULL-BODY FALL ARREST HARNESS MUST BE REPLACED AFTER THREE (3) YEARS OF SERVICE! REPLACE YOUR HARNESS IMMEDIATELY SHOULD YOU EXPERIENCE A FALL WHILE WEARING IT.**



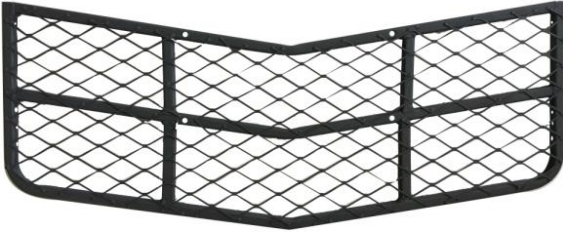
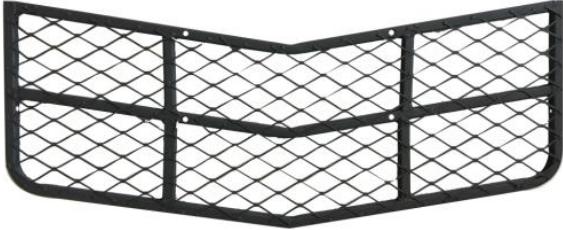




**WARNING!** Not to use without a Full Body Harness (Fall Arrest System) that meets the requirements of Test Method F2337. Use only the full-body fall arrest harness that has been tested by a third party testing laboratory to meet or exceed industry standards and is provided with this product.

**NOTE:** You must store your full-body harness out of direct sunlight and out of any other harsh environmental conditions that may adversely affect its performance. Failure to follow these instructions may result in serious injury or death! Read and understand the manufacturer's warnings, expiration date and instructions on how to use and how to properly adjust the harness.

## Tools Required (Provided)








1	Wrench (2 pcs)	
---	-------------------	--

# Parts List

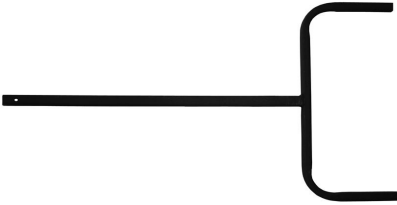

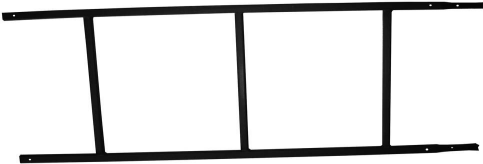
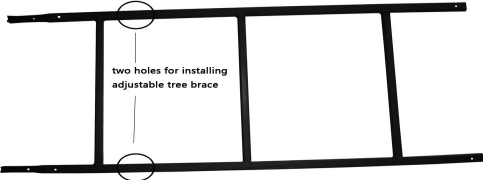

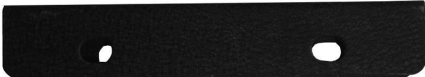

1	Seating Platform	<p>four holes on side</p> 	Qty <b>1</b>
2	Standing Platform	<p>one hole on side</p> 	Qty <b>1</b>
3	Arm Rest		Qty <b>2</b>
4	Seating & Standing Platform Support		Qty <b>2</b>
5	Back Rest Frame		Qty <b>1</b>
6	Back Rest Cushion		Qty <b>1</b>



# Parts List

7	Seat Cushion		Qty <b>1</b>
8	Tree Brace		Qty <b>2</b>
9	Ladder Brace		Qty <b>2</b>
10	Seating & Standing Platform Connect Bar		Qty <b>2</b>
11	Shooting Rail Support Bar		Qty <b>2</b>
12	Shooting Rail		Qty <b>1</b>
13	Adjustable Tree Brace		Qty <b>1</b>



# Parts List

14	Adjustable Tree Brace Mount		Qty 1
15	#4 Ladder Section		Qty 1
16	#3 Ladder Section		Qty 1
17	#2 Ladder Section	 <p data-bbox="701 981 819 1012">two holes for installing adjustable tree brace</p>	Qty 1
18	#1 Ladder Section		Qty 1
19	U-Bracket		Qty 8
20	Accessory Hook		Qty 2

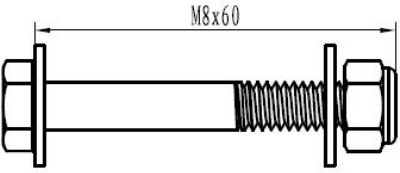
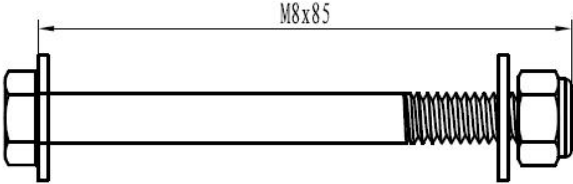
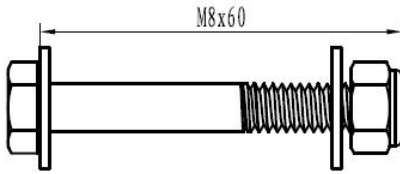
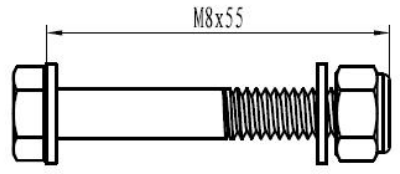
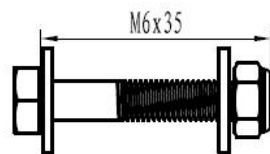
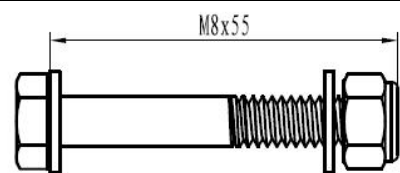
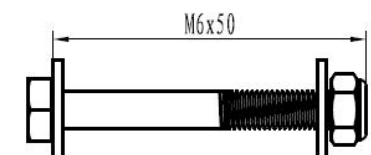
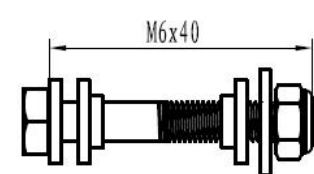
# Parts List

21	Mesh Shelf		Qty <b>1</b>
22	Shelf Support Tube		Qty <b>2</b>
23	Stabilizer Strap		Qty <b>2</b>
24	Ratchet Strap w/1 Hook		Qty <b>2</b>
25	Cam Buckle Strap		Qty <b>1</b>

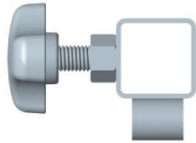
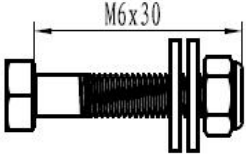
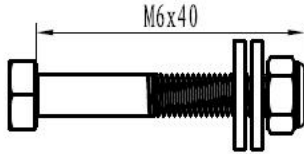
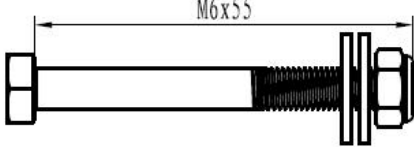
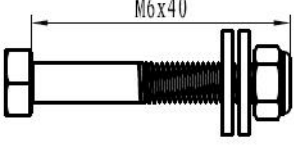
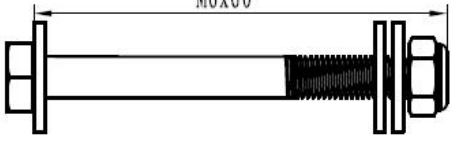
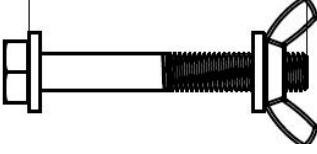
# Parts List

26	Yellow Tension Strap		Qty <b>1</b>
27	Full-Body Fall Arrest Harness with Instruction Manual		Qty <b>2</b>

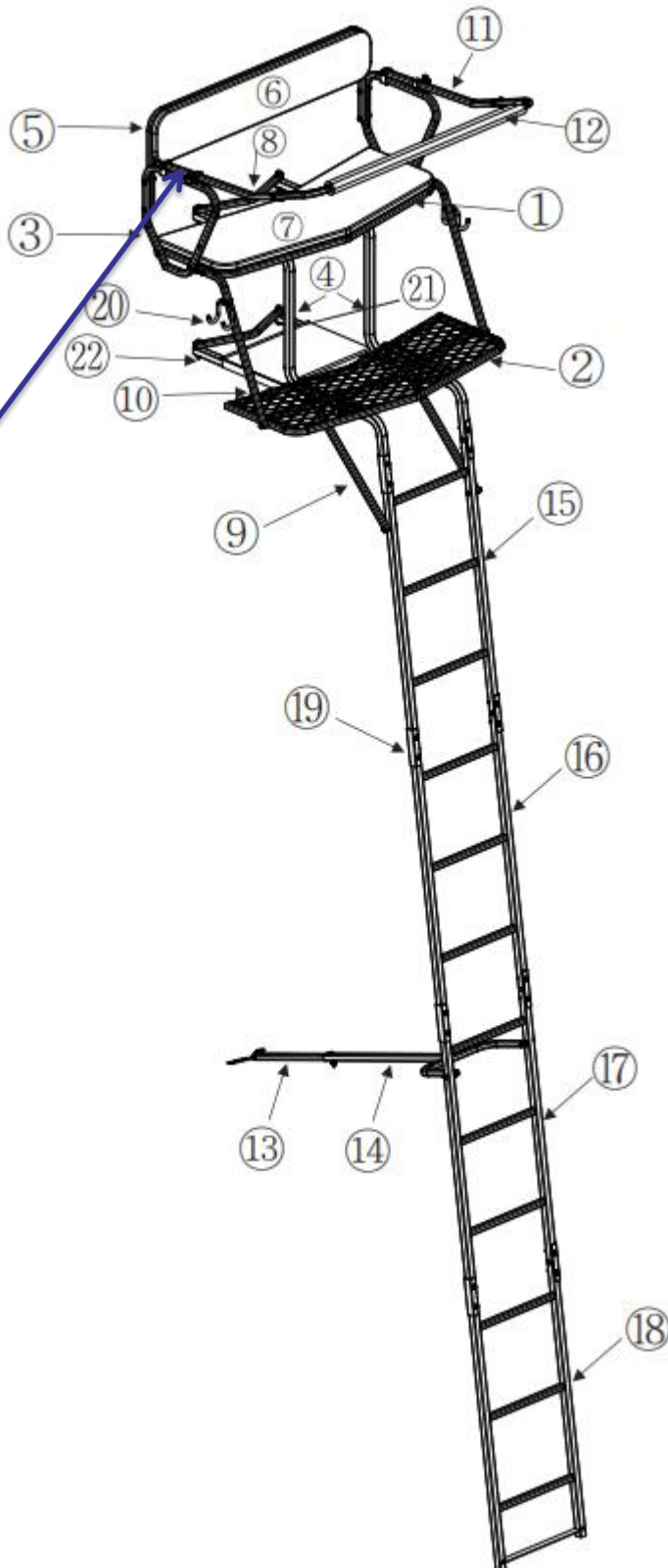
# Hardware

Step 1	M8X60 (with 2 steel washers and 1 locknut)		Qty <b>4</b>
Step 2	M8X85 (with 2 steel washers and 1 locknut)		Qty <b>4</b>
Step 4	M8X60 (with 2 steel washers and 1 locknut)		Qty <b>4</b>
Step 5-A	M8X55 (with 2 steel washers and 1 locknut)		Qty <b>6</b>
Step 5-B	M6X35 (with 2 steel washers and 1 locknut)		Qty <b>2</b>
Step 6	M8X55 (with 2 steel washers and 1 locknut)		Qty <b>4</b>
Step 7	M6X50 (with 2 steel washers and 1 locknut)		Qty <b>4</b>
Step 8	M6X40 (with 2 shoulder washers, 2 nylon washers and 1 locknut)		Qty <b>2</b>

# Hardware

<p>Step 8</p>	<p>M8X25 Handwheel Bolt with Steel Bushing</p>		<p>Qty  2</p>
<p>Step 9</p>	<p>M6X30 (with 2 steel washers and 1 locknut)</p>		<p>Qty  2</p>
<p>Step 10</p>	<p>M6X40 (with 2 steel washers and 1 locknut)</p>		<p>Qty  4</p>
<p>Step 11</p>	<p>M6X55 (with 2 steel washers and 1 locknut)</p>		<p>Qty  4</p>
<p>Step 13</p>	<p>M6X40 (with 2 steel washers and 1 locknut)</p>		<p>Qty  4</p>
<p>Step 14</p>	<p>M6X60 (with 3 nylon washers and 1 locknut)</p>		<p>Qty  2</p>
<p>Step 15</p>	<p>M6X45 (with 2 nylon washers and 1 wing nut)</p>		<p>Qty  1</p>

# Product Diagram



Product Identification Mark for Customer Service

#4 Ladder Section

#3 Ladder Section

#2 Ladder Section

#1 Ladder Section

# Assembly Instructions

## Step 1:

Locate the Seating Platform (#1). Install the Seating Platform (#1) onto the Seating & Standing Platform Supports (#4) using four (4) M8x60 Bolts, eight (8) Steel Washers and four (4) Locknuts as shown in Figure 1.

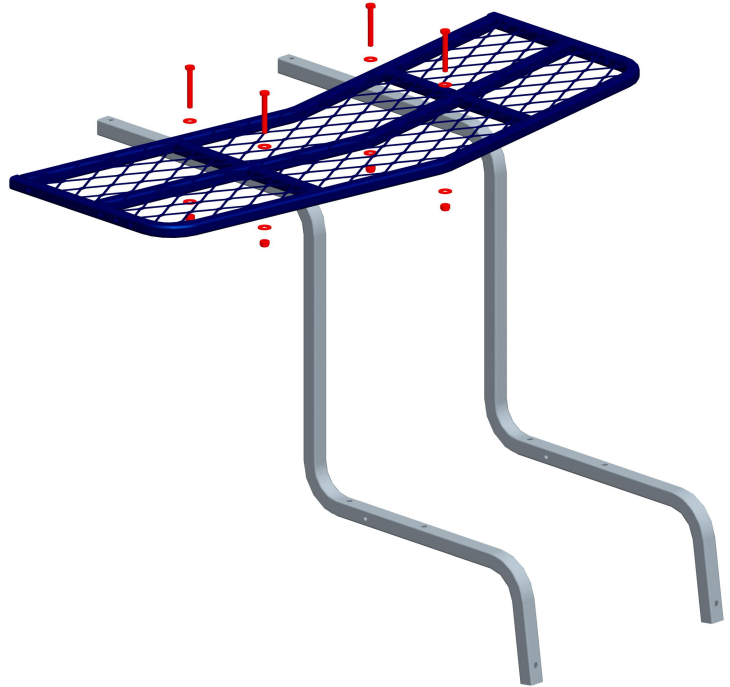


Figure 1

Install Seating Platform

## Step 2:

Locate the Standing Platform (#2) and the two shelf support tubes (#22) onto the Seating & Standing Platform Supports (#4) using four (4) M8x85 Bolts, eight (8) Steel Washers and four (4) Locknuts as shown Figure 2.

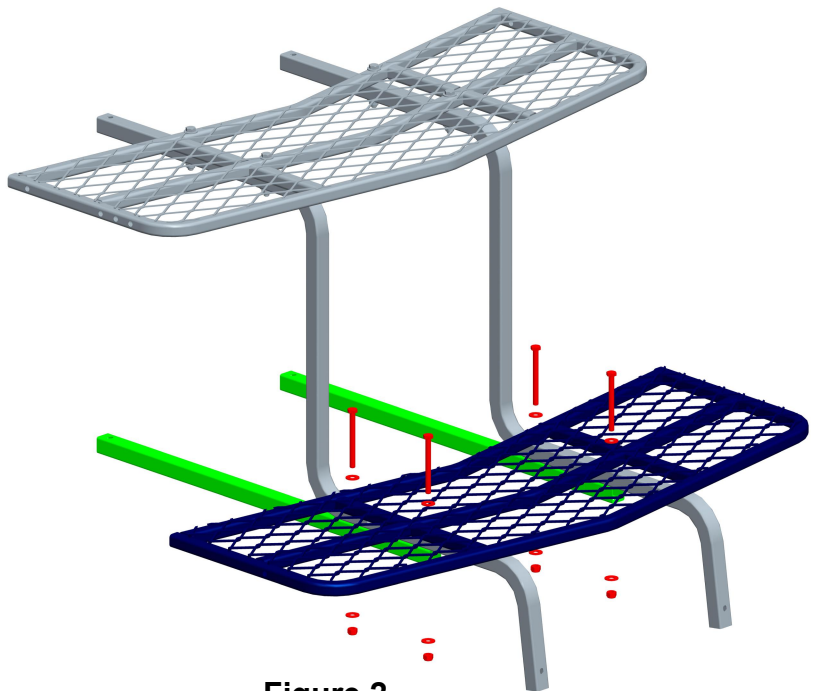


Figure 2

Install Standing Platform and two shelf support tube



# Assembly Instructions

## Step 3:

Insert the Mesh Shelf (#21) to the two tubes as shown in Figure 3.

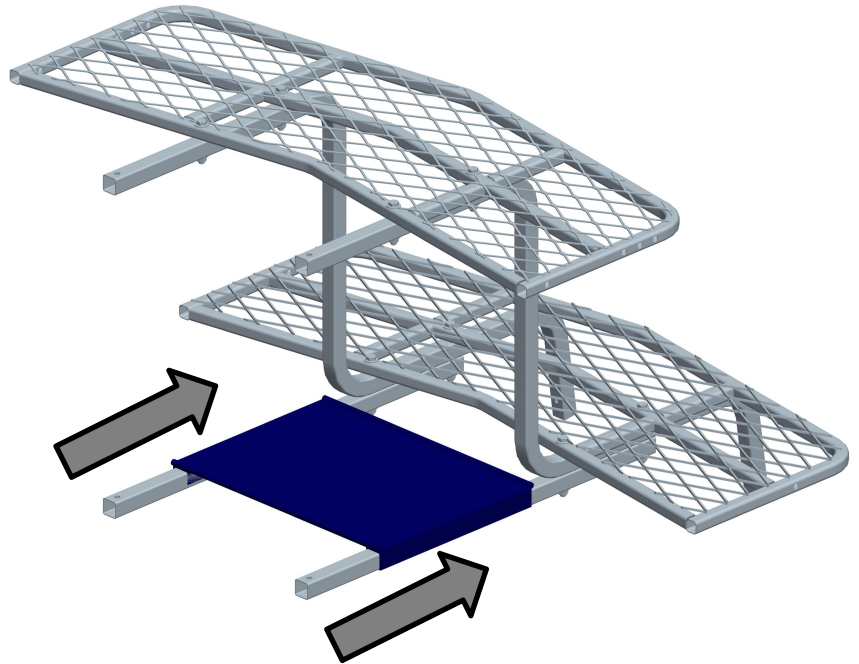


Figure 3

Insert the Mesh Shelf to the two tubes

## Step 4:

Locate the Tree Brace (#8). Install the Tree Brace (#8) onto the Seating & Standing Platform Supports (#4) and shelf support tube (#22) using four (4) M8x60 Bolts, eight (8) Steel Washers and four (4) Locknuts as shown in Figure 4.

### **WARNING:**

Do not over tighten the hardware. Overtightening can lead to structural damage and may negatively affect the performance of your stand.

Failure to follow these instructions may result in serious injury or death!

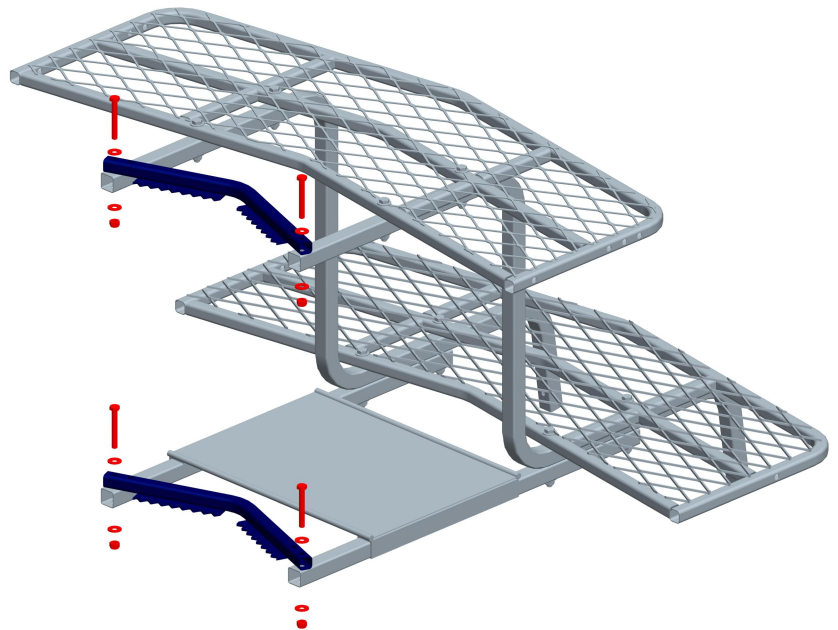


Figure 4

Install Tree Brace

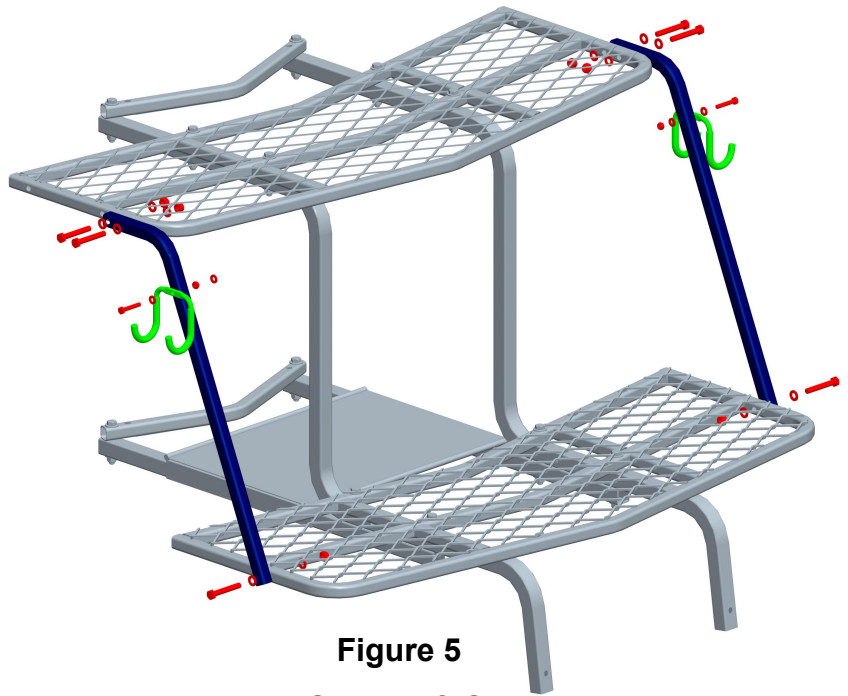
# Assembly Instructions

## Step 5:

Locate two Seating & Standing Platform Connect Bars (#10) and two Accessory Hooks (#20).

**A:** Install the Seating & Standing Platform Connect Bars (#10) onto the Seating & Standing Platform (#1,#2) using six (6) M8x55 Bolts, twelve (12) Steel Washers and six (6) Locknuts as shown in Figure 5.

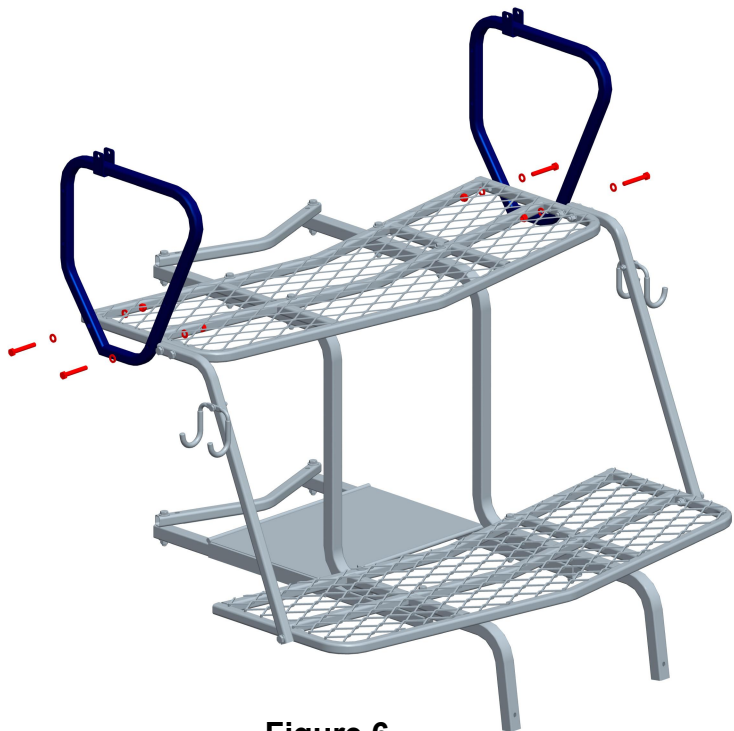
**B:** Install the Accessory Hooks (#20) onto the Seating & Standing Platform Connect Bars (#10) using two (2) M6x35 Bolts, four (4) Steel Washers and two (2) Locknuts as shown in Figure 5.



**Figure 5**  
**Install Seating & Standing Platform Connect Bars and Accessory Hooks**

## Step 6:

Locate two Arm Rests (#3). Install the Arm Rests (#3) onto the Seating Platform (#1) using four (4) M8x55 Bolts, eight (8) Steel Washers and four (4) Locknuts as shown in Figure 6.



**Figure 6**  
**Install Arm Rest**

# Assembly Instructions

## Step 7:

Locate Back Rest Frame (#5). Install the Back Rest Frame (#5) onto the Arm Rest (#3) using four (4) M6x50 Bolts, eight (8) Steel Washers and four (4) Locknuts as shown in Figure 7.

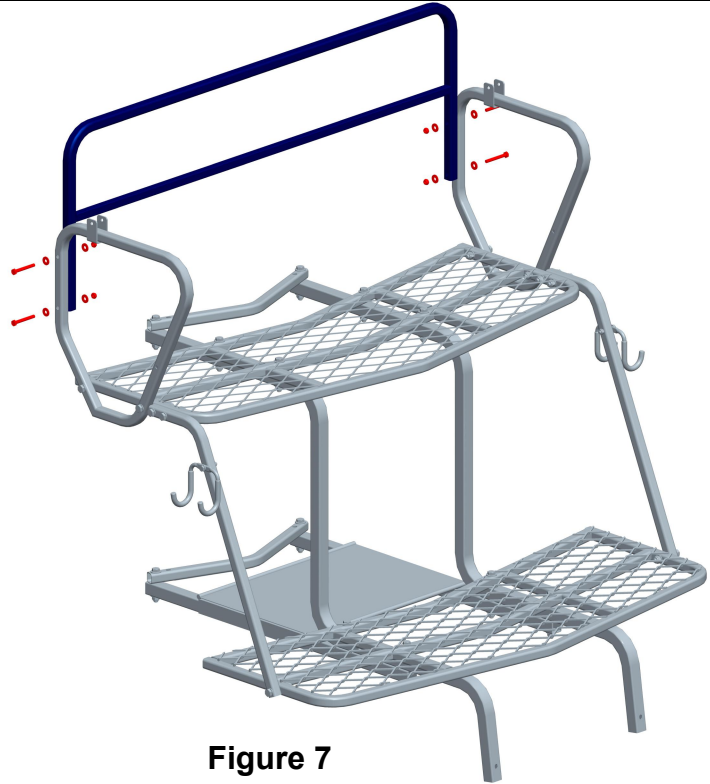


Figure 7

Install Back Rest Frame

## Step 8:

Locate two Shooting Rail Support Bars (#11). Slip two (2) Steel Bushings with M8x25 Handwheel Bolts into the Shooting Rail Support Bars (#11). Install the Shooting Rail Support Bars (#11) onto the two brackets of Arm Rests (#3) using two (2) M6x40 Bolts, four (4) Nylon Washers, four (4) thick Nylon Washers and two (2) Locknuts as shown in Figure 8.

**Note: Please place two (2) Thick Nylon Washers between the Arm Rest Bracket and the Shooting Rail Support Bar.**

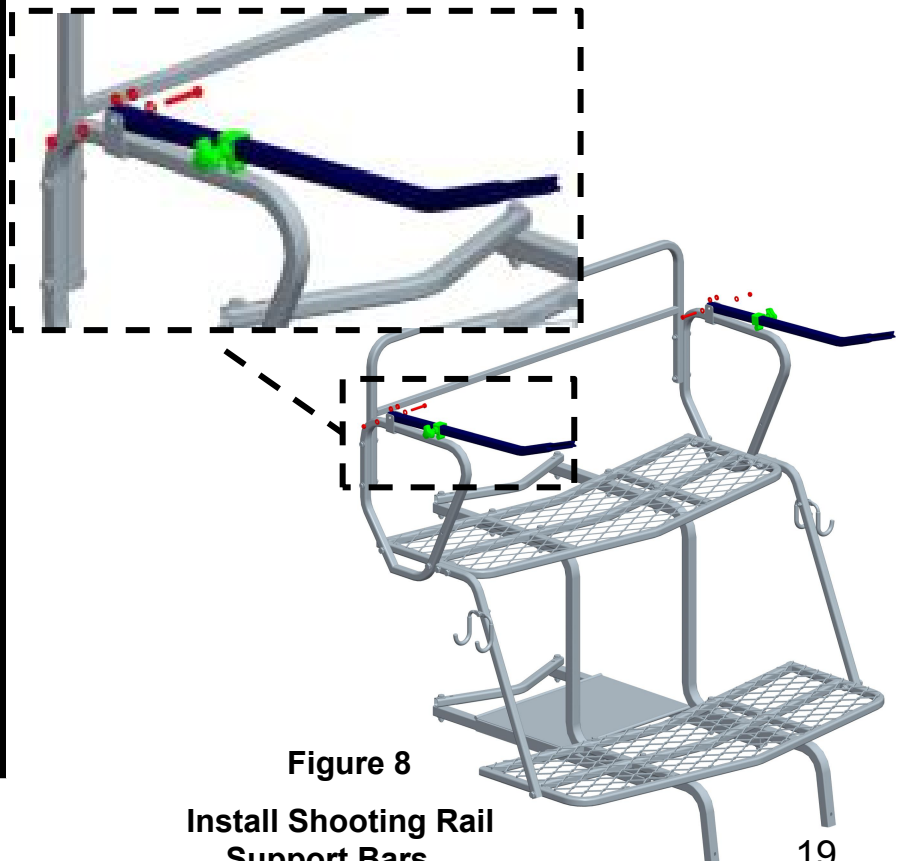


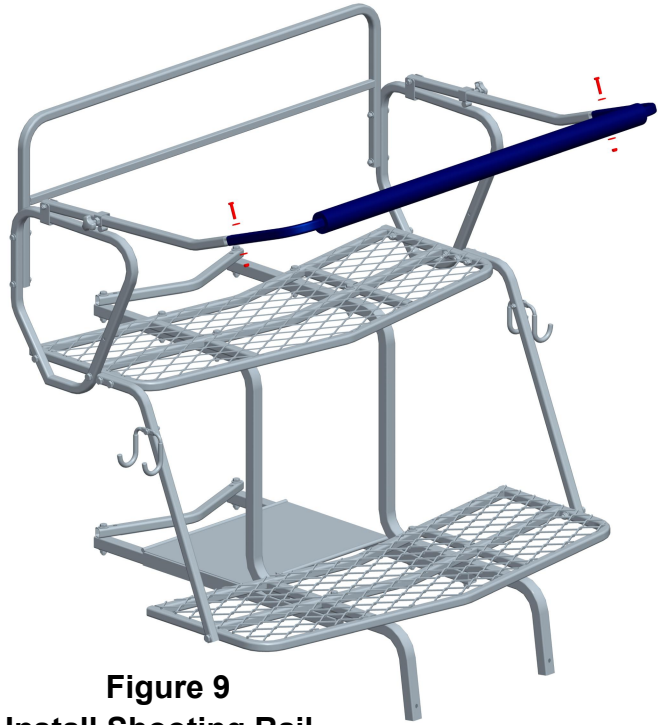
Figure 8

Install Shooting Rail Support Bars

# Assembly Instructions

## Step 9:

Locate Shooting Rail (#12). Install the Shooting Rail (#12) onto the Shooting Rail Support Bars (#11) using two (2) M6x30 Bolts, four (4) Steel Washers and two (2) Locknuts as shown in Figure 9.



**Figure 9**  
**Install Shooting Rail**

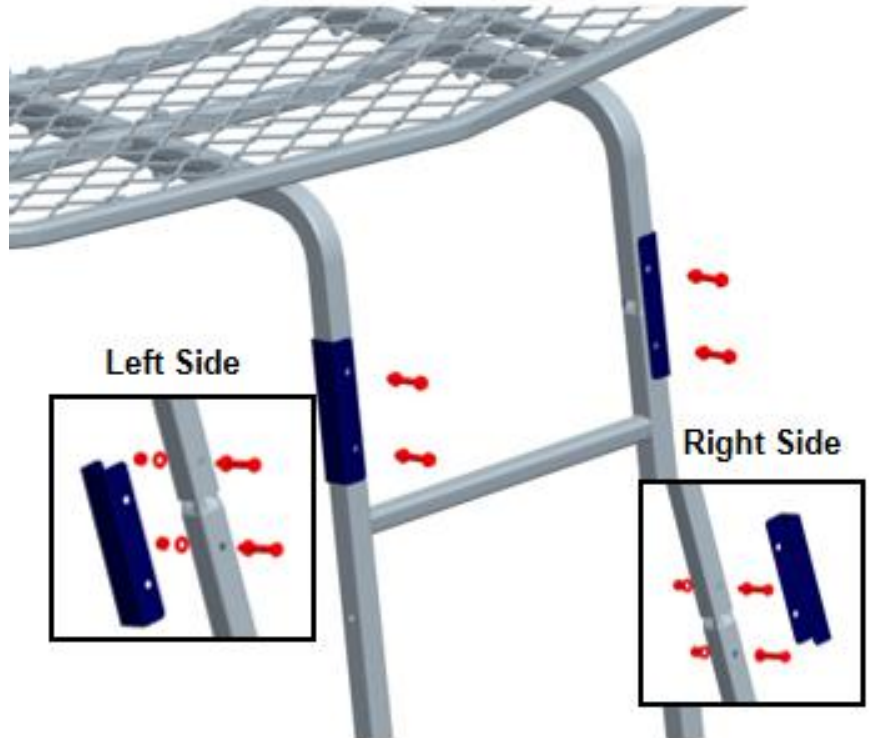
## Step 10:

Locate #4 Ladder Section (#15) and two U-Brackets (#19). Slip the crimped end of #4 Ladder Section (#15) into the Seating & Standing Platform Supports (#4) and secure with two U-Brackets (#19) using four (4) M6x40 Bolts, eight (8) Steel Washers and four (4) Locknuts as shown in Figure 10.

### **WARNING:**

U-Brackets are required and must be used to provide support for the attachment points between the ladder sections. Bolts must be threaded through them on both sides of the ladder section. DO NOT omit these U-Brackets.

Failure to properly use the U-Brackets could lead to serious injury or death.

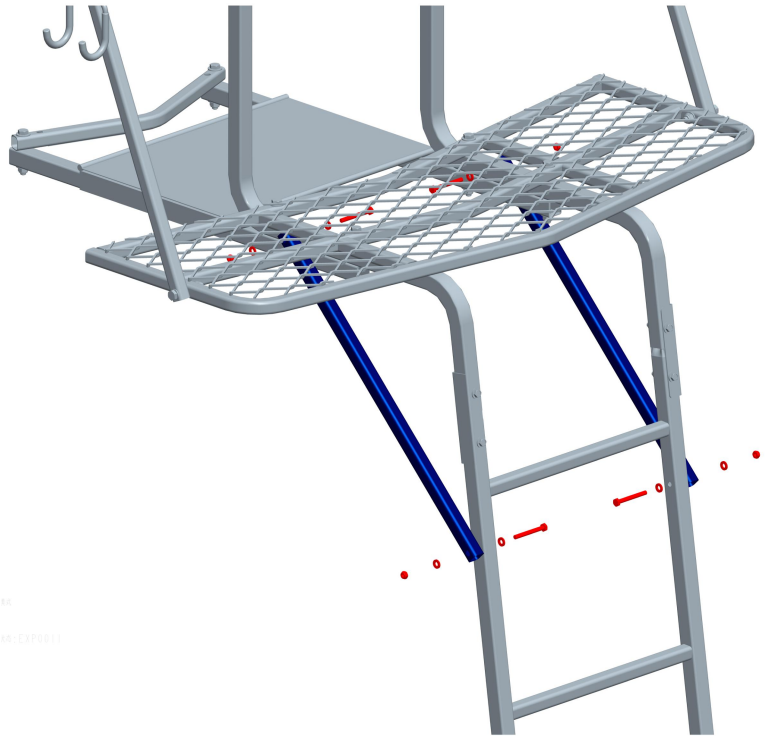


**Figure 10**  
**Install #4 Ladder Section**

# Assembly Instructions

## Step 11:

Locate two Ladder Braces (#9). Install two Ladder Braces (#9) onto the Seating & Standing Platform Supports (#4) and #4 Ladder Section (#15) using four (4) M6x55 Bolts, eight (8) Steel Washers and four (4) Locknuts as shown in Figure 11.



**Figure 11**

**Install Ladder Brace**

## Step 12:

Locate #3, #2, and #1 Ladder Section (part #16, #17, #18). Slip the male end of the #3 Ladder Section (#16) into the female end of the #4 Ladder Section (#15) as shown in Figure 12. Repeat this step for remaining two ladder section from #2 to #1.



**Figure 12**

**Install Ladder Sections**

# Assembly Instructions

## Step 13:

Locate six U-Brackets (#19). Secure 3 Ladder Sections with the U-Brackets (#19) using four (4) M6x40 Bolts, eight (8) Steel Washers and four (4) Locknuts per each Ladder Section as shown in Figure 13.

### **WARNING:**

U-Brackets are required and must be used to provide support for the attachment points between the ladder sections. Bolts must be threaded through them on both sides of the ladder section. **DO NOT** omit these U-Brackets. Failure to properly use the U-Brackets could lead to serious injury or death.

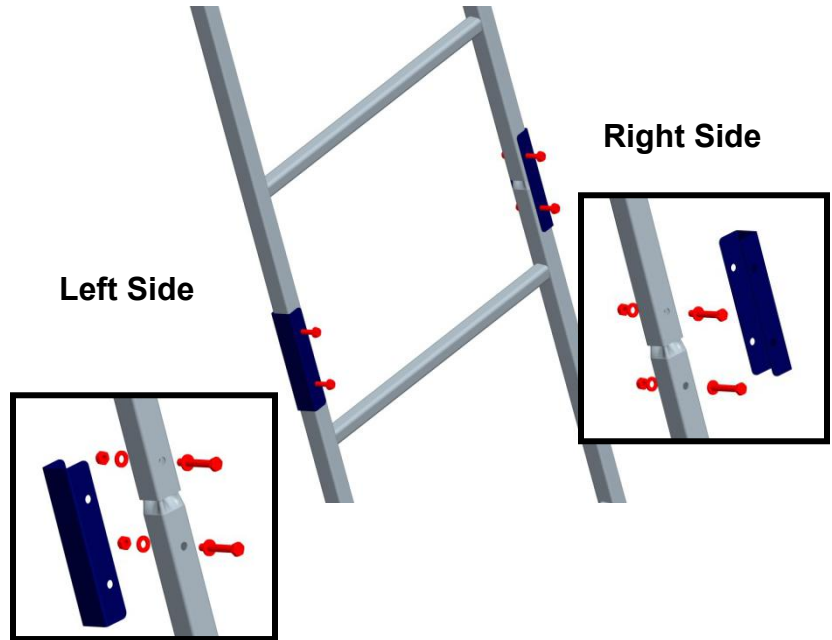


Figure 13

Ladder Sections Installed and Secured

## Step 14:

Locate Adjustable Tree Brace Mount (#14). Install the Adjustable Tree Brace Mount (#14) onto the #2 Ladder Section (#17) using two (2) M6x60 Bolts, six (6) Nylon Washers and two (2) Locknuts as shown in Figure 14.

**Note:** Please place one Nylon Washers between the Adjustable Tree Brace Mount and the #2 Ladder Section each side.

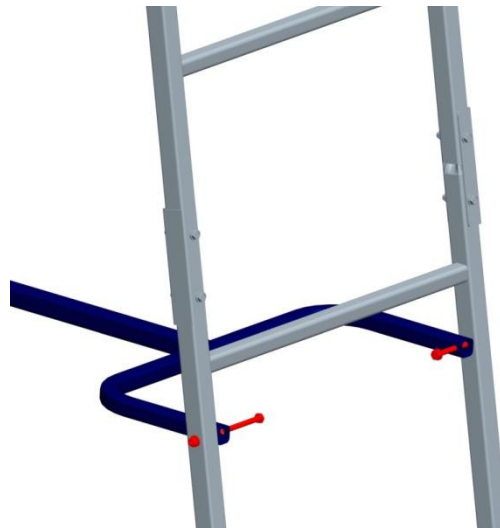


Figure 14

Install Adjustable Tree Brace Mount

# Assembly Instructions

## Step 15:

Locate Adjustable Tree Brace (#13). Slip the Adjustable Tree Brace (#13) into the Adjustable Tree Brace Mount (#14) and secure them using one (1) M6x45 Bolts, two (2) Nylon Washers and one (1) Wing Nut as shown in Figure 15.

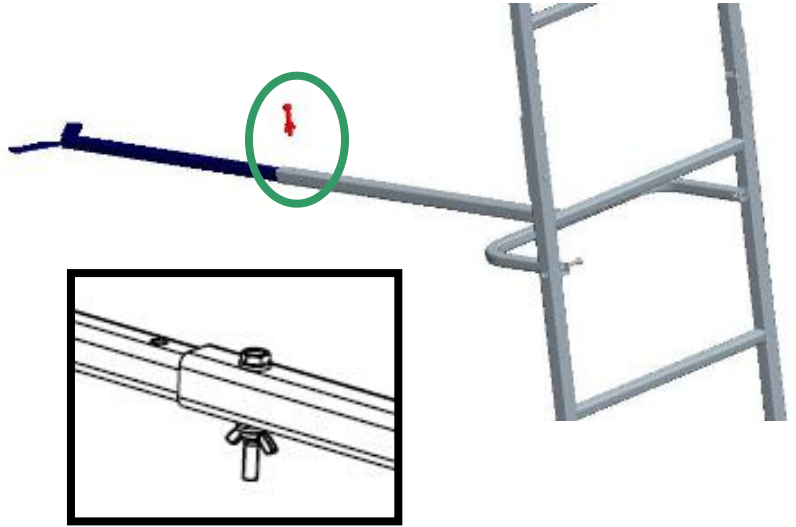


Figure 15

Install Adjustable Tree Brace

## Step 16:

Locate Backrest Cushion (#6) and Seat Cushion (#7).

Install the Backrest Cushion (#6) onto the Back Rest Frame (#5).

Install the Seat Cushion (#7) onto the Seating Platform (#1).

See figure 16.



Figure 16

Install Adjustable Tree Brace

# Installation Instructions

## SELECTING A SAFE TREE:



**TREESTAND MINIMUM AND MAXIMUM TREE SIZE: 9 – 24” DIAMETER!**

Never use treestand on a dead, leaning, diseased, loose barked tree, tree with excessive vines or on utility pole or any other man made structure.

Never use on trees that contain nails, screws, or other sharp objects that may cut, sever, or puncture strap webbing or cables!

Never rely on a tree branch for support!

Failure to follow these instructions can lead to serious injury or death!

- Select a healthy straight tree that fits within size limits larger than 9-inches in diameter and smaller than 24-inches in diameter at attachment height.
- Always thoroughly inspect tree from all sides before installing product.
- Be sure treestand platform is level. Tree must not lean or have any irregular shapes.
- Do not select a tree with vines or limbs below your desired hunting height.
- Never attach treestand to limbs! Always attach treestand to main trunk of tree.
- Never use treestand on trees with wet, icy, slippery, loose or scaly bark.

## PRACTICE AND BECOME FAMILIAR WITH PRODUCT AT GROUND LEVEL:

Always practice attaching/detaching, adjusting and using treestand and full body harness at ground level prior to using at elevated positions.

Prior to using treestand and full body harness at elevated positions for first use of each season, test operation and use at ground level.

## FULL BODY SAFETY HARNESS (FALL ARREST SYSTEM – FAS):



You must wear and use supplied 4 point full body harness when installing and using this treestand.

Always connect harness to tree as soon as possible and prior to stepping on the platform and always remain harness to tree until you leave platform.

Read and understand included Full Body Harness Instructions, Warnings, and watch safety video for instructions on using your full body harness.

Failure to follow these instructions can result in serious injury or death.

Refer to Full Body Harness (FAS) Instruction Manual supplied with this treestand for proper wear, adjustment, usage and maintenance.

**THE REST OF THE INSTRUCTIONS IN THIS MANUAL REQUIRE YOU TO WEAR AND USE THE SUPPLIED 4 POINT FULL BODY HARNESS SUPPLIED WITH THIS TREESTAND.**



# Installation Instructions

## SETTING UP THE GAME WINNER LADDER STAND ONTO THE TREE

**!** WARNING! STOP! Make sure that you are wearing your full-body fall arrest harness. Failure to follow these instructions may result in serious injury or death!

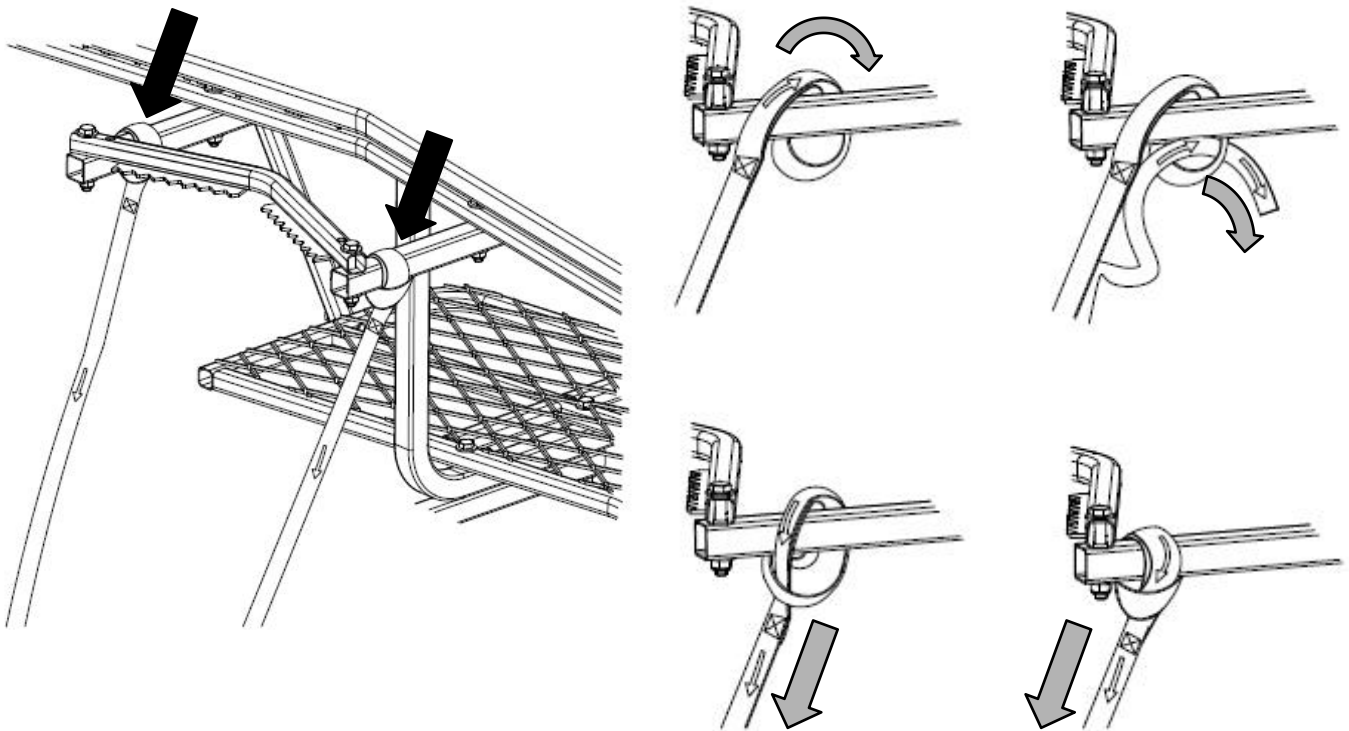
**!** WARNING! Prior to attempting to use this, or any other Game Winner product(s), you must take a moment and become familiar with its setup and installation at ground-level. You must practice installing, setting-up using and removing product(s) and full-body safety harness at ground-level prior to attempting to use it at heights above ground-level. Once you have become thoroughly knowledgeable and comfortable with this Game Winner product(s) setup, installation use and removal at ground-level, you're now ready to use it at heights above ground-level. Failure to follow these instructions may result in serious injury or death!

### STEP 1:

Select a straight healthy tree that is larger than 9-inches in diameter and smaller than 24-inches in diameter at attachment height.

### STEP 2A:

Attach two (2) Stabilizer Straps (#23) to both the left and right side of the seating platform supports where tree brace meets the support as shown in Figure 17a. Attach by looping strap loop around support and insert end of strap through strap loop. Pull tight so strap is secure on side of seating platform support and positioned next to tree brace. Repeat for strap on other side of seating platform support.



**Figure 17a**  
**Install Stabilizer Straps**

## Installation Instructions

### STEP 2B:

Attach one (1) Ratchet Strap (#24) to either side of the upper tree brace between support frame and tree teeth. Attach one (1) Ratchet Strap (#24) to lower tree brace between support frame and tree teeth. See Figure 17b. Using same looping method as stabilizer straps in Figure 17a, attach ratchet straps by looping strap loop around support frame and insert ratchet with strap and hook through strap loop. Pull tight so strap is secure on tree brace positioned between support frame and tree teeth.

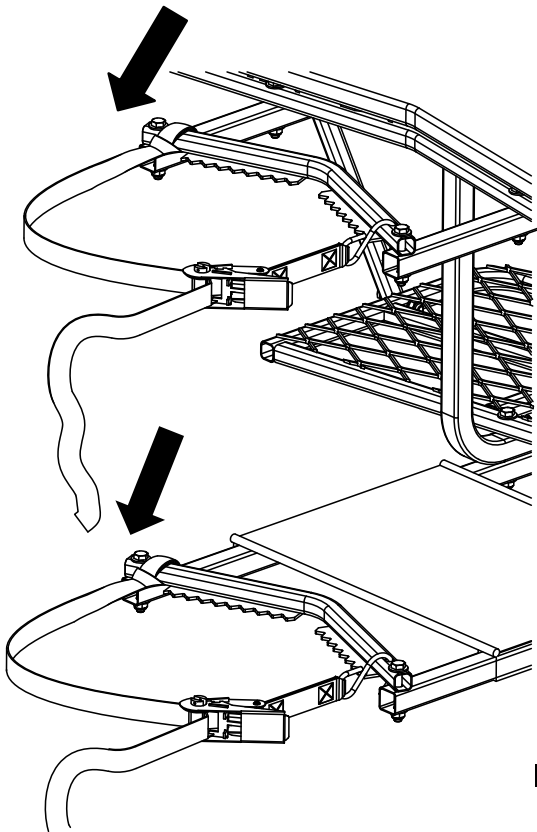
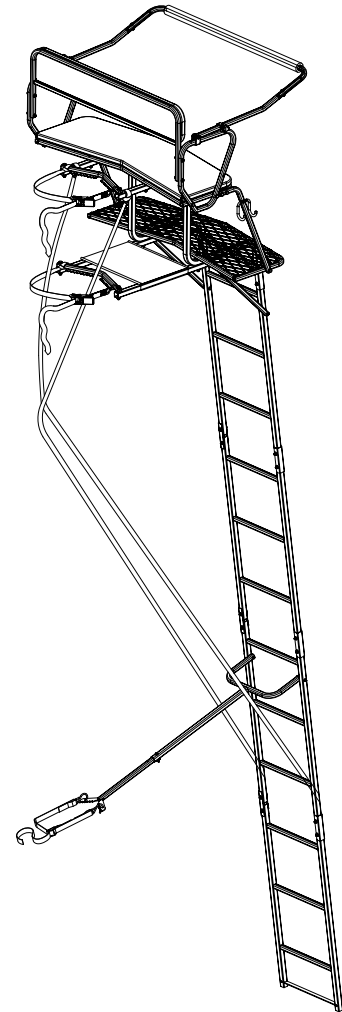


Figure 17b  
Install Ratchet Straps



**!** WARNING! Make sure ratchet straps and/or strap loops do not contact tree teeth.

### STEP 3:

Allow Straps to hang freely from the seating platform.

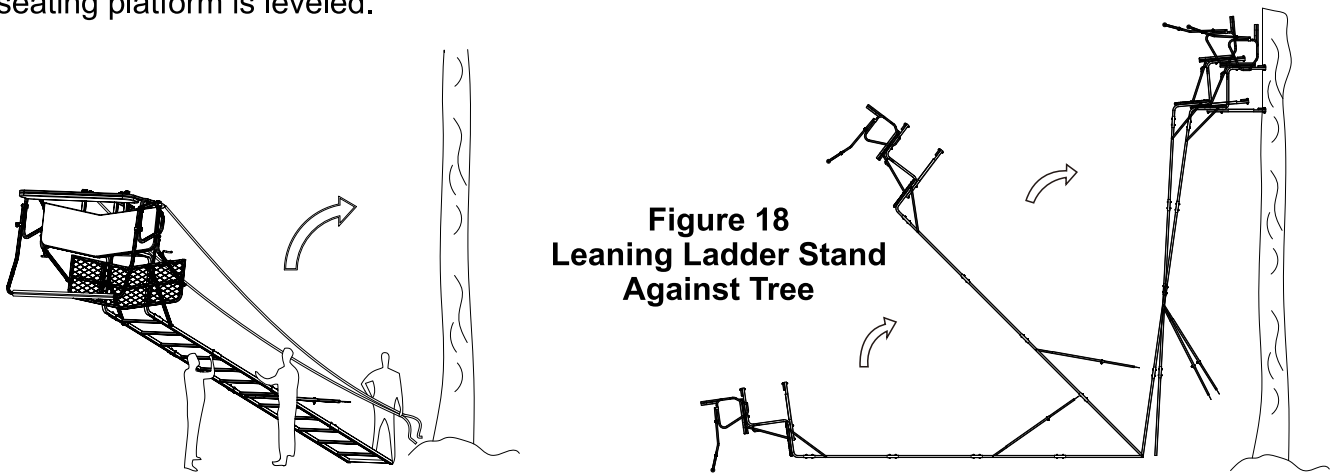
**!** WARNING! You must check the ground under the treestand to make sure it is firm and level. Sloping ground or uneven surfaces (e.g., one foot on a rock) can cause your ladder to tilt or shift off the tree as you climb. Prior to attempting to climb a ladder stand for the first time, make certain the feet of the bottom rung ladder section are firmly planted on solid, level ground. If they are not firmly planted on level ground, DO NOT climb the ladder. Failure to follow these instructions may result in serious injury or death!

**!** WARNING! Your Game Winner Ladder is designed, engineered and constructed in a manner that makes it a rugged piece of hunting equipment that will give you years of trouble-free service. This rugged-construction makes your Game Winner Ladder physically heavy. As such, you should never attempt to install this ladder by yourself. YOU MUST HAVE A MINIMUM OF THREE (3) ADULTS FOR THE SAFE ERECTION OF YOUR treestand. In addition to helping carry the heavier construction of the stand, the use of three people are required for set up. Failure to follow these instructions may result in serious injury or death!

# Installation Instructions

**STEP 4:** You are now ready to lean your ladder stand up against the tree. Please note that it takes a minimum of three (3) adults to perform this operation. With the ladder stand laying flat on the ground in front of the tree, place the legs approximately 3' to 4' from the base of the tree.

**STEP 5:** Have one adult hold bottom of ladder while guiding/pulling stand with stabilizer straps while other two adults lift the platform and walk ladder stand up to tree as shown in Figure 18. Gently allow the two(2) tree braces come to rest on the trunk of the tree. At this point, step back from the tree and determine if the ladder stands platform is level. If it is not level, move the legs of the lower ladder section closer or further from the tree (as appropriate) until the seating platform is leveled.

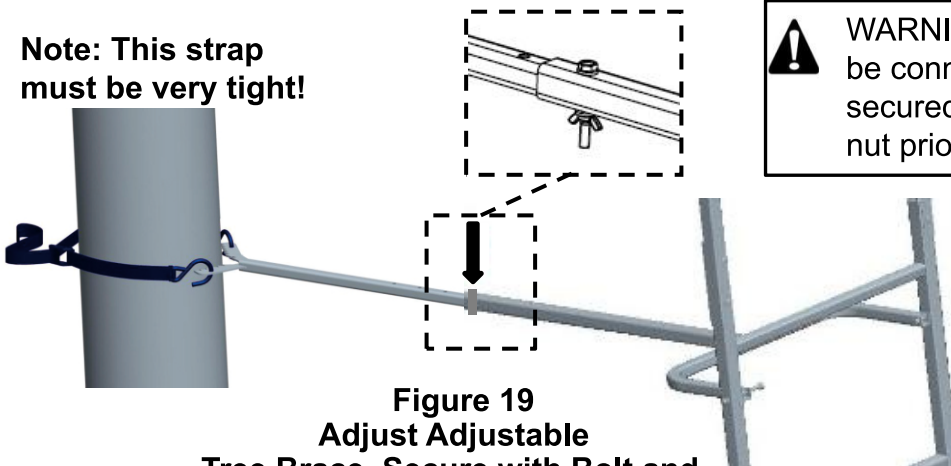


**Figure 18**  
Leaning Ladder Stand  
Against Tree

**WARNING!** Always make sure platform is level! If platform is leaning forward, reposition treestand or select different tree.

**STEP 6:** Once the ladder stand platform has been leveled, have one adult step and bounce on bottom ladder rung to set ladder into ground. Adjust tree brace assembly by lengthening or shortening so it fits snugly against the tree trunk and provides rigid support to the ladder sections. Adjust the braces length so it is snug against the tree trunk. Once the adjustable tree brace is snug and the standing and seating platform are level, secure with (1) M6x45 Bolt, (2) washers and (1) wing nut as shown in Figure 15 and install the Cam Buckle Strap (#25) onto the adjustable tree brace assembly as shown in Figure 19 and tighten.

**Note: This strap must be very tight!**



**WARNING!** Tree brace must be connected to tree and secured with bolt and wing nut prior to climbing ladder.

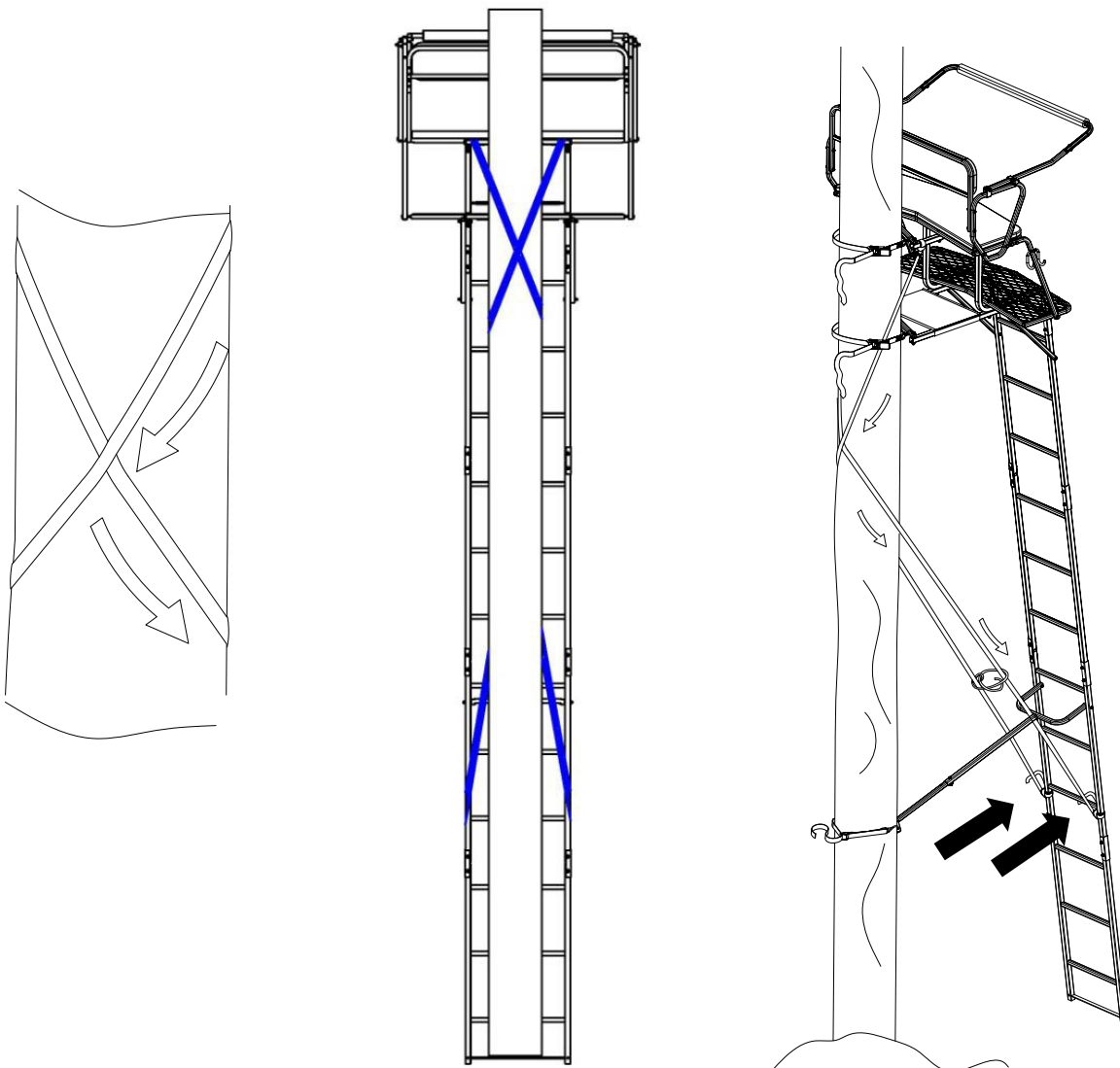
**Figure 19**  
Adjust Adjustable  
Tree Brace, Secure with Bolt and  
Wing Nut and Tighten Strap.

## Installation Instructions

**STEP 7:** Now take the stabilizer straps (#23) and crisscross them behind the tree trunk and pull them snug tying them to a rung on the middle ladder section (or the highest rung you can safely reach from the ground) as shown in Figure 20.

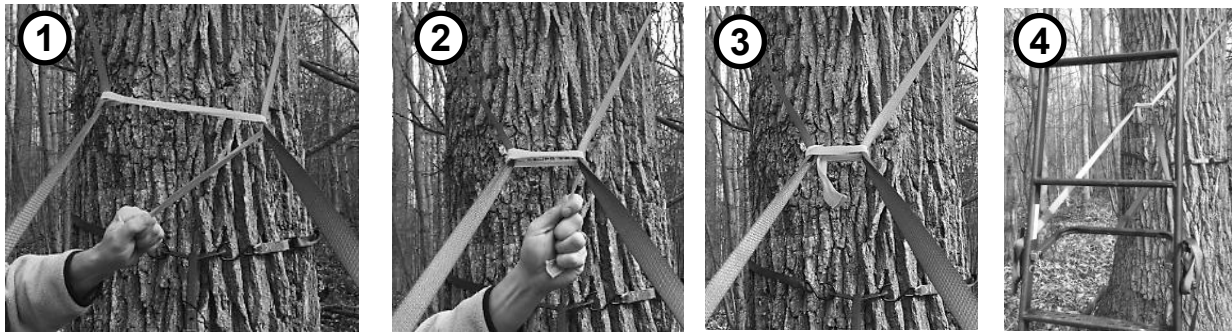


**WARNING!** Prior to climbing, make sure that all the ladder sections are firmly connected, tree brace is secure to tree (with bolt and strap), stabilizer straps are installed and the ladder assembly is solidly secured to the tree. Failure to follow these instructions may result in serious injury or death!



**Figure 20**  
**Stabilizer Straps**  
**Installed**

# Installation Instructions



**Figure 21**

Connect Yellow Tension Strap

**STEP 8:** Wrap yellow tension strap (#26) around both stabilizer straps and pull tight drawing stabilizer straps together. Wrap tension strap around drawn stabilizer straps 3 to 4 times and tie off tension strap so it will not loosen (refer to Figure 21).

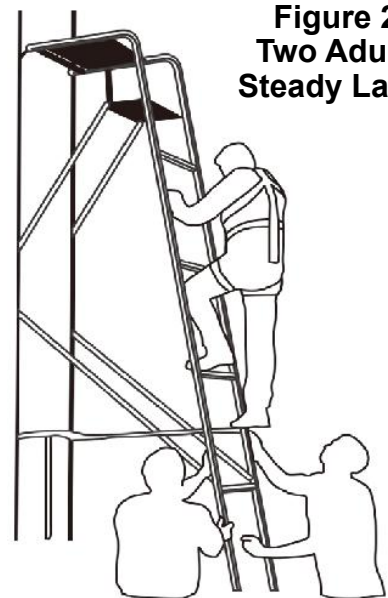
**!** **WARNING!** Prior to attempting to climb a ladder stand for the first time, make certain the feet of the bottom rung ladder section are firmly planted on solid, level ground. If they are not firmly planted on level ground, **DO NOT** climb the ladder. With three (3) adults, lower the stand and find a suitable location to safely install the ladder stand. Failure to follow these instructions may result in serious injury or death!

**!** **WARNING!** When climbing to secure the ratchet straps, always have two (2) adults hold base of ladder steady against tree. Always lean forward when climbing to keep the stand centered and secure to the tree trunk. **DO NOT** lean backwards when climbing! Failure to follow these instructions may result in serious injury or death!

**!** **WARNING!** When climbing, always maintain three points of contact as you ascend (climb up) and while descending (climb down). Failure to maintain three points of contact puts the user at serious risk of bodily injury. Failure to follow these instructions will result in serious injury or death!

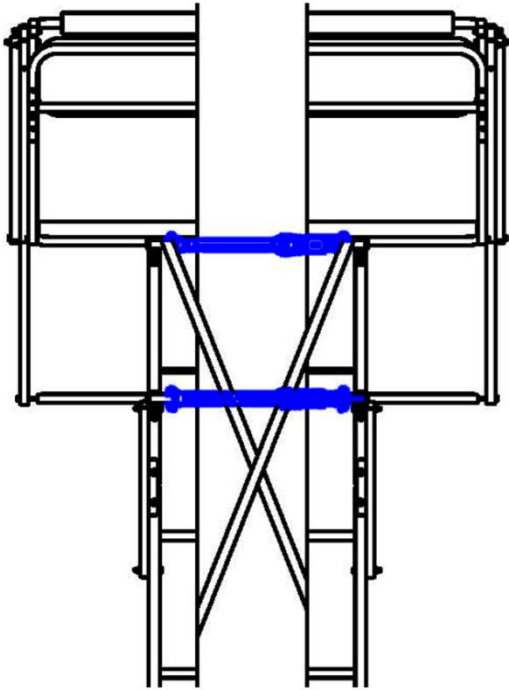
**!** **WARNING!** As you approach the top of the ladder, attach your full-body fall arrest harness tether to the tree trunk as soon as possible. After your tether has been attached to the tree, attach the ratchet straps to secure the top of the stand to the tree. **DO NOT** sit or stand on the standing platform until the ratchet straps have been securely fastened. Failure to follow these instructions may result in serious injury or death!

**STEP 9:** With two (2) other adults holding the base of the ladder stand, steady against tree (refer to Figure 22), climb to a height that allows you to safely attach your full-body fall arrest harness tether to the tree trunk as soon as possible. After your tether has been attached to the tree trunk securing your position, attach the ratchet strap (#24) to secure the top of the stand to the tree. To install the ratchet strap (#24), wrap the ratchet strap around the tree trunk and attach hook to the opposite side on the seating platform frame as shown in Figure 23. Make sure the ratchet strap is very tight. Repeat this for the lower ratchet strap (#24) by attaching it to back of shelf support frame. **NOTE:** For ratchet threading instructions, refer to Figure 24. **NEVER ATTEMPT TO THREAD A RATCHET ABOVE GROUND LEVEL.**

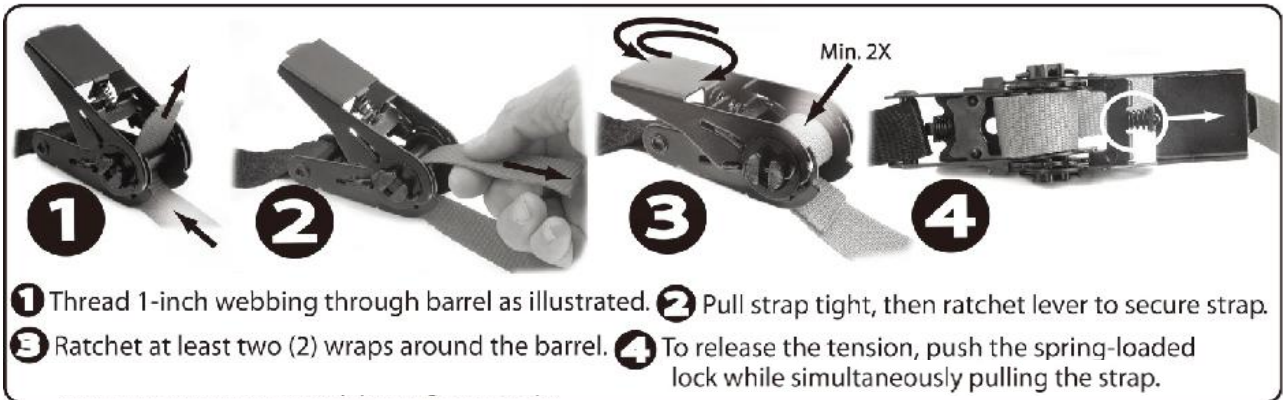
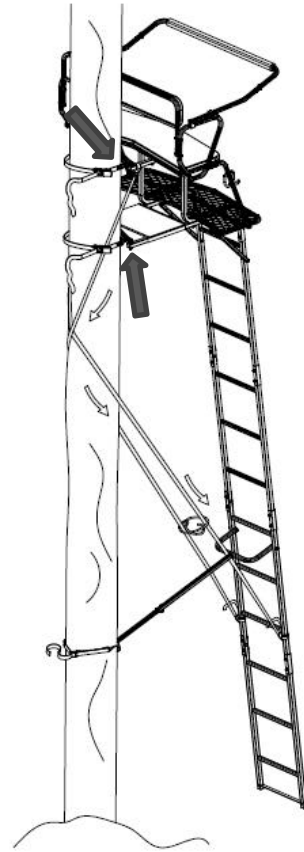


**Figure 22**  
**Two Adults**  
**Steady Ladder**

# Installation Instructions



**Figure 23**  
**Ratchet Straps Installed**



**Figure 24 Threading Ratchet Strap**

**! WARNING! DO NOT** use this, or any other Game Winner product(s) to climb utility poles, telephone poles, structural columns or any other man-made structures. Never use this or any other Game Winner product(s) around power generation (e.g., transformers, generators, substations, etc) and/or power transmission equipment. Failure to follow these instructions may result in serious injury or death!

**STEP 10: HUNTING:** Once at height, always remain harnessed to the tree with your full body harness. Harnesses must be worn and attached to the tree at all times during a hunt, prior to ever stepping on the platform, and should not be removed until you begin your descent. Hunt safely. Wear and properly use your harness.

# Usage



## WARNING!

Before each use, inspect treestand and all safety devices for damage including but not limited to corrosion, cracks, deformity, bends, rot, wear, cuts or fraying and other damage to tree straps, crimps, hardware, platform, upright, seat, etc. Do not use if damage, wear, deterioration, vandalism, etc. is detected or suspected.

Before each use, do not climb ladder or use without having crossing straps attached tight, stabilizer bar attached to tree, bolt with wing nut installed and main ratchet strap attached.

Before climbing ladder, always check every ladder section connection to assure sections are not separating. If ladder sections are separating, do not use the stand.

Always maintain 3 points of contact when climbing up/down ladder and in/out of treestand.

Do not use treestand with more than 2 people. Never have more than 1 person on ladder at any one time.

Always use hoist rope to pull up bow, crossbow, firearm, backpack or other gear only after being secured in treestand. Firearm, crossbow, and bow must be pulled up unloaded with firearm chamber open and muzzle down. Never climb with anything on your back.

Never rely on tree branch for support.

Do not jump, bounce, hop, rock back and forth, etc. on treestand.

Do not lean out or against treestand, armrest or shooting rail. Always stay centered on platform with minimal movement.

Always position safety harness tree strap with tether above your head so tether is minimized at all times.

Never allow tether strap to get under your chin or around your neck.




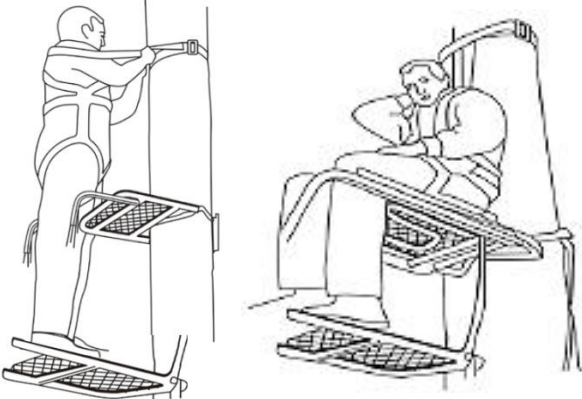

Hunt from ground when self-recovery/escape ability is absent.

Do not stand on footrest (if included) or treestand seat.

Failure to follow these instructions can result in serious injury or death.

- Never hunt out of a treestand at heights you are not completely comfortable. Depending on tree and conditions, choose minimum height that allows for safe and effective hunting.
- Never hurry! While climbing, make slow, even movements and make sure you have proper 3 point contact with treestand every time you move.
- Always inform someone of hunting location, where treestand will be located, and expected duration of hunt.
- Always have second adult present or at least accessible by cell phone or other means when using treestand. Ability to get help quickly may save your life in event of a fall.
- Always take and use signal device (mobile phone, radio, whistle, signal flare or personal locating device (PLD)) when using this product. Always keep signal device on you and readily available at all times.







# Usage

STEP	INSTRUCTION	IMAGE
1	<p>At ground level, put on full body harness following harness manufacturer's instructions. If you are not wearing harness, STOP and do not leave the ground.</p>	<div style="border: 1px solid black; padding: 5px;">  <p><b>Read and understand included Full Body Harness Instructions, Warnings and watch safety video for instructions on using your Full Body Harness</b></p> </div>
2	<p>Have 1 person (adult) climb ladder using 3-point climbing method while leaning forward. Before stepping onto platform, attach full body harness to tree.</p> <div style="border: 1px solid black; padding: 5px; margin-top: 20px;">  <p><b>ALWAYS FOLLOW INCLUDED SAFETY HARNESS INSTRUCTION</b></p> </div>	<div style="border: 1px solid black; padding: 5px;"> <p><b>Always maintain three points of contact when climbing ladder and entering or exiting platform.</b></p> <p><b>Always lean forward as you climb and attach harness to tree before securing platform to tree and stepping onto platform.</b></p> <p><b>Never grab seat as handle to get into or out of treestand.</b></p> <p><b>Never step onto platform without first being attached to tree with full body harness.</b></p> </div>
3	<p>Step onto platform and adjust tree strap above your head so tether is under tension when sitting.</p> <div style="border: 1px solid black; padding: 5px; margin-top: 20px;">  <p><b>ALWAYS FOLLOW INCLUDED SAFETY HARNESS INSTRUCTION</b></p> </div> <p>While sitting have 2<sup>nd</sup> person enter following above steps.</p> <p><b>You are now ready to hunt.</b></p>	
4	<p><b>Exit Treestand</b></p> <p>With one person sitting, have other person face tree and detach full body harness from tree. Use 3 point climbing method while leaning forward to climb down ladder. When first person is on ground, 2<sup>nd</sup> person (adult) can face tree, detach harness from tree and use 3 point climbing method while leaning forward to climb down.</p>	<div style="border: 1px solid black; padding: 5px;">  <p><b>When exiting, face tree and step down onto ladder. When both feet are on ladder step, lean forward and disconnect harness from tree. Then proceed to climb down ladder.</b></p> </div>











# Removal Instructions

## Removing Your Game Winner Ladder Stand

-  **WARNING! STOP!** Make sure that you are wearing your full-body fall arrest harness. Failure to follow these instructions may result in serious injury or death!
-  **WARNING!** When climbing to remove the ratchet strap, always have two (2) adults hold base of ladder steady. Always lean forward when climbing to keep the stand centered and secure to the tree trunk. **DO NOT** lean backwards when climbing! Failure to follow these instructions may result in serious injury or death!
-  **WARNING!** When climbing, always maintain three points of contact as you ascend (climb up) and while descending (climb down). Failure to maintain three points of contact puts the user at serious risk of bodily injury. Failure to follow these instructions will result in serious injury or death!
-  **WARNING!** As you approach the top of the ladder, attach your full-body fall arrest harness tether to the tree trunk as soon as possible. After your tether has been attached to the tree, remove the ratchet straps. Failure to follow these instructions may result in serious injury or death!
-  **WARNING!** Always keep crossing straps, stabilizer bar, and bolt with wing nut **ATTACHED** to three! Remove Last! Failure to follow these instructions may result in serious injury or death!
-  **WARNING!** Never drop ladder stand out of tree as this may damage treestand. Always use three (3) adults to slowly lower stand to ground.

**STEP 1:** With three (3) adults, reverse installation instructions to remove your Game Winner Ladder.

# Care and Maintenance

-  **WARNING!** Proper maintenance and inspection is required for this product. Thoroughly inspect this or any other Game Winner product(s) prior to use for signs of wear, rot, corrosion, cracks, fraying, deterioration and/or any other type of damage. DO NOT use this or any other Game Winner product(s) if they show evidence of wear, rot, corrosion, cracks, fraying, deterioration and/or any other type of damage. Failure to follow these instructions may result serious injury or death!
-  **WARNING!** DO NOT allow this product to be kept outdoors for more than two weeks (14 days). DO NOT expose this product for extended periods to direct sunlight, high wind, bad weather conditions, excessive heat or freezing temperatures. Exposure to such weather conditions can be unpredictable and can lead to damage of the product. Allowing a product to remain unattended may also result in damage to the product that could be caused by a variety of sources, including but not limited to tree growth vandals, animals or other sources. Inspect the product upon removal and prior to every installation and use.
-  **WARNING!** Do not remove, modify any portion or otherwise mechanically modify this product or its assemblies in any manner. Make certain that all parts are used in the assembly of this product. Parts are designed and tested to work together. Modification, additions, misuse, part omission or substitution shall immediately void your factory warranty and may result in serious injury or death! If you suspect a part(s) is missing and/or damaged, immediately contact Innopower Inc. at (949) 262-3416 for replacement of missing or defective parts. Never modify your stand in any way by making repairs, altering, omitting, adding or attaching anything to it. ALWAYS USE GENUINE FACTORY AUTHORIZED INNOPOWER INC. REPLACEMENT PARTS. USE OF ANY REPLACEMENT PARTS OTHER THAN GENUINE INNOPOWER INC. PARTS VOIDS YOUR WARRANTY AND RELIEVES INNOPOWER INC. OF ANY RESULTANT LIABILITIES AND MAY RESULT IN SERIOUS INJURY OR DEATH!
-  **WARNING!** Replace all hardware/cables/nuts/bolts/clips on your treestand if inspection reveals any damage, including but not limited to wear, rot, corrosion, cracks, fraying, deterioration and/or any other type of damage. Use only Game Winner replacement parts. The product is tested to be used only with genuine Game Winner parts. Use of any other parts, which are not genuine Game Winner parts, constitutes a modification to the product and could result in serious injury or death. Any modification will void the warranties and relieve Innopower Inc. from all liabilities. Failure to follow these instructions may result in serious injury or death!
-  **WARNING!** Replace tree strap and cables every two years or sooner if wear, damage, deterioration, rust, cuts, tears, rot, etc. or vandalism is detected or suspected. Only replace with official Game Winner replacement parts.
-  **WARNING!** Replace full body harness every three years or sooner if wear, damage, deterioration, cuts, tears, rot, etc. are detected or suspected.
-  **WARNING!** Inspect all safety devices each time before each use. DO NOT use these devices if they show signs of wear, damage, deterioration, vandalism, fraying or other damage. Factors such as tree growth, vandals, weather and animals may affect the performance of an unattended treestand or safety device. Do not store these devices outdoors when not in use. Failure to follow these instructions may result in serious injury or death!
-  **WARNING!** NEVER adjust ANY straps, cables, and/or adjustable support bars while standing on treestand. Make all adjustments at ground level. DO NOT use any treestand if there is wear, rot, corrosion, cracks, fraying, deterioration and/or any other type of damage on any part of the treestand. Failure to follow these instructions may result in serious injury or death!

Store treestand and full body safety harnesses indoors in a clean, dry environment free from direct sunlight, harmful chemicals, excessive heat and dust. Exposure to sunlight, excessive heat and the elements can weaken tree strap or affect its performance.

# Warranty Information

## Important Warranty Information

Innopower Inc. warrants this Game Winner product against defect(s) in material and workmanship, under proper use and storage, for the period of one (1) year from the date of purchase. Proof of purchase, plus, the return of your warranty application card to our home office, is required for any warranty claim. In the events this product is found to be defective within the warranty period, Innopower Inc.'s only obligation and your exclusive remedy shall be replacement or repair of any defective parts at our discretion. To obtain warranty service, please contact Innopower Customer Service at (949) 262-3416. Exclusions to this warranty include seat, paint, plastics, webbing and/or defects caused by operator misuse and/or abuse. Limitation to liability include the forgoing warranty is made in lieu of all other warranties, express or implied and Innopower Inc. disclaims any implied warranty of merchantability and fitness. Innopower Inc. shall not be liable for any damages direct, consequential or incidental arising out of the use or inability of this product.

### Warranty Application Card

I have read and understand the safety, assembly and operating instructions provided with my Game Winner product. I have read the warranty information and know that I can call Innopower Inc. at **(949) 262-3416** with any questions or concerns that I may have about this or any other Game Winner product. Mail to: INNOPOWER INC.

PO Box 265, E. Irvine, CA 92650. Email: [customerservice@innopower.biz](mailto:customerservice@innopower.biz)

Name \_\_\_\_\_ Purchase Location \_\_\_\_\_

Address \_\_\_\_\_

City/State/Zip \_\_\_\_\_

Purchase Date \_\_\_\_\_

Product \_\_\_\_\_

Manufactured by Innopower Inc., PO Box 265, E. Irvine, CA 92650