



GAME WINNER™

Instruction Manual Game Winner 18' Full Platform Ladder Stand

164835

Maximum Weight Capacity (User and Equipment) - 300 pounds (136 kg)



ATTENTION

YOU MUST READ ALL WRITTEN INSTRUCTIONS AND WATCH THIS SAFETY VIDEO BEFORE USING!



WATCH THIS SAFETY VIDEO BEFORE USING!

Scan →



or Visit →

www.standsafety.com/in3

Scan the QR code with your smart phone, tablet or similar device.

OR

Type the website address into your web browser to view an important safety video before using this product.

LADDER STAND SAFETY



Every year people are injured from hunting related falls. Most of these injuries could have been prevented by following the instructions and warnings provided with the treestand and safety harness. Tree stands are used at height and falls can result in serious injury or death. Your own safety, and the safety of any user of this product, should be your first priority. In order to reduce your risk of injury, you **MUST** read and thoroughly understand all of the safety warnings, usage instructions and other information contained within the written and safety video instructions and warnings provided with this product, and any other hunting equipment used. Retain the instructional and warning materials and review them periodically (at least once a year and always with any new user). Failure to follow all instructions and warnings may lead to serious injury or death. **DO NOT USE THIS PRODUCT UNTIL AND UNLESS YOU HAVE READ AND THOROUGHLY UNDERSTAND ALL INSTRUCTIONS, SAFETY WARNINGS AND OTHER MATERIALS.** If you have any questions, do not use the product until you have contacted the manufacturer at 949-262-3416 or email customerservice@innopower.biz.

Business Hours:

Monday through Friday, **8:00** am to **5:00** pm ET. If you are unable to speak with a representative, please leave a voicemail with your contact information and your call will be returned within one (1) business day.

For Customer Service, please call **949-262-3416** or

E-mail: customerservice@innopower.biz

(Made In China)

Warnings	3-7
Tools Required	7
Parts List	8-12
Hardware	13-15
Product Diagram	16
Assembly Instructions	17-27
Installation Instructions	28-34
Usage	35-36
Removal Instructions	37
Care and Maintenance	38
Warranty Information	39

Note: Before beginning assembly of product, make sure all parts are present. Compare parts with package content list and hardware contents. If any part is missing or damaged do not attempt to assemble the unit. Contact customer service for replacement parts.

Warnings

ATTENTION!



WHEN YOU SEE A  SYMBOL OR THE WORD "WARNING!" BE SURE TO READ THE MESSAGE! THE INFORMATION CONTAINED IN THESE MESSAGES CAN SAVE YOUR LIFE OR PREVENT SERIOUS INJURY!! BE SAFE! FOLLOW ALL WARNINGS!!



WARNING! FALLS FROM A TREESTAND CAN OCCUR ANYTIME AFTER LEAVING THE GROUND. THESE FALLS RESULT IN EITHER SERIOUS INJURY OR DEATH! FOR YOUR PERSONAL SAFETY, PLEASE TAKE A MOMENT TO CAREFULLY READ THIS PRODUCT INSTRUCTION MANUAL IN ITS ENTIRETY BEFORE ATTEMPTING TO ASSEMBLE, SET-UP, INSTALL AND/OR OTHERWISE USE THIS GAME WINNER PRODUCT. ANNUALLY REVIEW THE CONTENTS OF THIS INSTRUCTION MANUAL. ADDITIONALLY, KEEP THESE INSTRUCTIONS FOR THE ENTIRE DURATION YOU OWN THIS PRODUCT(S). FAILURE TO FOLLOW THESE INSTRUCTIONS MAY RESULT IN SERIOUS INJURY OR DEATH!



WARNING! THE SAFE USE AND OPERATION OF THIS PRODUCT(S) IS THE SOLE RESPONSIBILITY OF THE USER. IT IS THE SOLE RESPONSIBILITY OF THE OWNER TO PROVIDE ANY PERSON(S) WHO BORROW OR PURCHASE THIS PRODUCT WITH ALL WRITTEN AND SAFETY VIDEO INSTRUCTIONS AND WARNINGS PRIOR TO USE. DO NOT ALLOW A PERSON TO USE THE PRODUCT THAT HAS NOT REVIEWED ALL WRITTEN AND SAFETY VIDEO INSTRUCTIONS AND WARNINGS PRIOR TO USE. FAILURE TO FOLLOW THESE INSTRUCTIONS MAY RESULT IN SERIOUS INJURY OR DEATH! STORE ALL WRITTEN AND SAFETY VIDEO INSTRUCTIONS AND WARNINGS IN A SAFE LOCATION WHERE THEY CAN BE SHARED WITH POTENTIAL USERS. IF ANY INSTRUCTIONS OR WARNINGS ARE LOST OR DISCARDED, DO NOT USE THE PRODUCT AND DO NOT ALLOW ANY OTHER PERSON TO USE THE PRODUCT.



WARNING! THIS PRODUCT CARRIES A STRICT WEIGHT LIMITATION. DO NOT USE THIS PRODUCT IF YOU EXCEED THIS TOTAL WEIGHT LIMIT. PLEASE NOTE THIS WEIGHT LIMIT INCLUDES THE USER AND EQUIPMENT. FAILURE TO FOLLOW THESE INSTRUCTIONS MAY RESULT IN SERIOUS INJURY OR DEATH!



WARNING! Prior to each hunt, make certain you have a signaling device (e.g., mobile phone, cell phone, radio, whistle, signal flare, Personal Locator Device [PLD], etc.) in your possession and on your person in an operable condition. This device must be within easy access should you experience the need to contact emergency assistance. Failure to follow this instruction may result in serious injury or death!



WARNING! Thoroughly inspect this or any other Game Winner product(s) prior to use for signs of wear, rot, corrosion, cracks, fraying, deterioration and/or any other type of damage. DO NOT use this or any other Game Winner product(s) if they show evidence of wear, rot, corrosion, cracks, fraying, deterioration and/or any other type of damage. Failure to follow these instructions may result serious injury or death!



WARNING! Do not remove, modify any portion or otherwise mechanically modify this product or its assemblies in any manner. Make certain that all parts are used in the assembly of this product. Parts are designed and tested to work together. Modification, additions, misuse, part omission or substitution shall immediately void your factory warranty and may result in serious injury or death! If you suspect a part(s) is missing and/or damaged, immediately contact Innopower Inc. at (949) 262-3416 for replacement of missing or defective parts. Never modify your stand in any way by making repairs, altering, omitting, adding or attaching anything to it. ALWAYS USE GENUINE FACTORY AUTHORIZED INNOPOWER INC. REPLACEMENT PARTS. USE OF ANY REPLACEMENT PARTS OTHER THAN GENUINE INNOPOWER INC. PARTS VOIDS YOUR WARRANTY AND RELIEVES INNOPOWER INC. OF ANY RESULTANT LIABILITIES AND MAY RESULT IN SERIOUS INJURY OR DEATH!











WARNING! This product is designed for adult use only. No one under the age of 18 should attempt to use this product or any other Game Winner product(s) without direct adult supervision..















WARNING! Prior to attempting to use this or any Game Winner product(s), you must take a moment and become familiar with its assembly, setup, installation and removal. You must practice setting-up using and removing the product(s) at ground level prior to attempting to use it at heights above ground-level. Once you have become thoroughly knowledgeable and comfortable with this products set-up, use and removal at ground-level, you are now ready to use it at heights above ground-level. Failure to follow these instructions may result in serious injury or death!

Warnings









-  **WARNING!** When hunting from a treestand, falls can occur any time after leaving the ground causing injury or death. Always wear your full-body fall arrest system (FAS) comprising a full-body harness, tether, tree belt and Suspension Relief Device at all times after leaving the ground. When using a ladder stand, you must connect to the tree as soon as possible and prior to stepping on the platform of the treestand. Please read and review your full body harness instructions and the safety video for instruction of the safe use of harnesses when using a ladder treestand. Single safety belts and chest harnesses are no longer allowed and should never be used as they put the user at serious risk of injury or death. If you are not wearing your full-body arrest harness properly attached to the tree that is protecting you from a fall, do not leave the ground. Failure to follow these instructions may result in serious injury or death!
-  **WARNING!** Never rely on a tree branch for support while climbing. Failure to follow these instructions may result in serious injury or death!
-  **WARNING!** You must always inform someone of your hunting location, where the treestand will be located and the expected duration of the hunt. Failure to follow these instructions may result in serious injury or death!
-  **WARNING!** Inspect all safety devices each time before each use. DO NOT leave ground or use these devices if they show signs of wear, damage, deterioration, vandalism, fraying or other damage. Factors such as tree growth, vandals, weather and animals may affect the performance of an unattended treestand or safety device. Do not store these devices outdoors when not in use. Failure to follow these instructions may result in serious injury or death!
-  **WARNING!** Practice using your full-body fall arrest harness at ground-level in the presence of a responsible adult to experience the feeling of hanging suspended before using in a hunting environment. Failure to follow these instructions may result in serious injury or death!
-  **WARNING!** The length of the full-body fall arrest tether must be minimized at all times. It should be adjusted so that it is above the head with no slack (snug) in the sitting position and you should have the minimum amount of slack possible when climbing. Failure to follow these instructions may result in serious injury or death!
-  **WARNING!** Never attempt to climb up or climb down with a weapon and/or gear period. ALWAYS unload your weapon and pull it up to hunting height using pull up rope when raising or lowering firearms; the chamber must be open and the barrel pointing toward the ground. ALWAYS lower your unloaded weapon down to the ground prior to attempting to climb down. Use this same method when raising or lowering all other gear. Failure to follow these instructions may result in serious injury or death!
-  **WARNING!** Failure to follow harness instructions could result in not being able to return to the stand and being suspended in a harness after a fall. If your hunting location is unknown by anyone and communications efforts are unsuccessful, you must have a personal plan for self-recovery/escape should you experience a fall. Prolonged suspension in a harness can be fatal. It is important to exercise the legs by pushing against the tree or doing other forms of continuous leg exercise to avoid blood pooling while being suspended. Varying degrees of physical fitness may require different plans for self-recovery/escape to avoid the effects of prolonged suspension. Have a personal plan and practice it in the presence of a responsible adult before leaving the ground. No one escape/rescue plan will work for every hunter, on every tree, in every circumstance. Only you can determine the best self-recovery/escape plan for your hunting situation and you must have a self-recovery/escape plan for your individual situation before leaving the ground. There is time to make a correct decision on what action to take if a fall occurs while wearing a full-body fall arrest harness. It is important to remember, "DO NOT PANIC." You must only hunt from the ground when self-recovery/escape ability is absent. Failure to follow these instructions may result in serious injury or death!
- Several optional products/systems are available that offer self-recovery or self extraction from a fall when suspended in a harness. Some systems automatically descend the user while others allow user control. One of these products/systems can be considered for use as an additional safety precaution against prolonged suspension and suspension trauma. Be sure to follow the manufacturers' directions on the safe use of these products/systems.
-  **WARNING!** A suspension relief device must be on your person and readily accessible while using your full-body fall arrest harness. These devices allow the user to relieve the load on the lower extremities if suspended in a harness and help maintain circulation in the legs, mitigate suspension trauma (blood pooling) or allow descent to the ground. Be sure to follow the directions on the safe use of any suspension relief device. Failure to follow these instructions may result in serious injury or death!

Warnings

-  **WARNING!** If you have a limiting physical and/or health condition, **DO NOT** hunt from heights above ground level. Hunt from the ground when self-recovery/escape ability is absent. Failure to follow these instructions may result in serious injury or death!
-  **WARNING!** **NEVER** allow the harness tether to get under your chin or around your neck. This poses a choking hazard that can lead to serious injury or death. Failure to follow these instructions may result in serious injury or death!
-  **WARNING!** **DO NOT** attempt to use this and/or any other Game Winner product(s) when ice, snow and/or freezing rain has deposited or formed on any portion of the tree you intend to climb. Failure to follow these instructions may result in serious injury or death!
-  **WARNING!** **ALWAYS** maintain three (3) point contact when climbing up/down when using this product. Proper three (3) point contact means having either two (2) feet with one (1) hand on step or one (1) foot with two (2) hands on the step portion of the climbing aids at all time when climbing up or down. Failure to follow these instructions may result in serious injury or death!
-  **WARNING!** **NEVER** adjust any straps, cables, and/or adjustable support bars while standing on treestand. Make all adjustments at ground level. **DO NOT** use any treestand if there is wear, rot, corrosion, cracks, fraying, deterioration and/or any other type of damage on any part of the treestand. Failure to follow these instructions may result in serious injury or death!
-  **WARNING!** **DO NOT** modify, fix/repair, alter, bend, cut, weld, or heat this product in any way. Failure to follow these instructions may result in serious injury or death!
-  **WARNING!** **DO NOT** lean out from a treestand for any reason. Never use your full-body arrest harness to help you lean out from your treestand to make a difficult shot. Failure to follow these instructions may result in serious injury or death!
-  **WARNING!** **DO NOT** use this product or attempt to use this product on a dead, leaning, diseased, loose barked tree (bark that flakes or falls off), irregular shaped trees or utility poles. **DO NOT** use this product on any tree that does not allow for a level standing platform. Failure to follow these instructions may result in serious injury or death!
-  **WARNING!** Never jump or bounce on a treestand for any reason. Failure to follow these instructions may result in serious injury or death!
-  **WARNING!** Never leave a treestand in a tree for more than two (2) weeks (14 days). Weather, elements, animals, vandalism, and/or other mechanisms could damage the treestand. Tree growth can also stress and damage straps, chains and buckles. Failure to follow these instructions may result in serious injury or death!
-  **WARNING!** **DO NOT** use this or any other Game Winner product(s) if you have a history of heart problems, back problems, impaired vision, joints that lock-up, spinal fusions, equilibrium problems, high blood pressure, are not well-rested and/or any other physical impairment that may limit your ability to use and/or operate this product(s) in the safe manner outlined in this instruction manual. Additionally, do not use this or any other Game Winner product(s) if you are currently taking any medication (including prescription or over-the-counter [OTC]) and/or using and/or consuming any substance, or consumed any substance, including alcohol, that may limit your ability to use this product as outlined and described in this instruction manual. Never use a treestand when feeling ill, nauseous or dizzy. Do not use any Game Winner product(s) without consent from your medical doctor. Failure to follow these instructions may result in serious injury or death!
-  **WARNING!** **DO NOT** attempt to use this or any other Game Winner product(s) when lightning or thunderstorms are threatening and/or present within five (5) miles. Do not attempt to use this or any other Game Winner product(s) during or under threat of any adverse weather condition. This includes weather conditions which have the potential for producing winds, lightning, rain, snow, sleet and/or any other atmospheric condition which may limit the user's ability to operate this product in a safe manner as described in this instruction manual. Should inclement weather conditions arise during your use of this product, return to the ground immediately. Failure to follow these instructions may result in serious injury or death!

Warnings

SPECIAL CONSIDERATIONS FOR LADDER TREESTAND USAGE

-  **WARNING!** You must use at least three (3) adults to install and/or take down this ladder treestand. Failure to follow these instructions may result in serious injury or death!
-  **WARNING!** You must install and attach the crisscross straps and the described stabilization devices as described in this manual prior to attempting to climb this treestand. These devices add necessary balance and support for the complete climbing system. Failure to properly use and attach those items, and to follow these instructions may result in serious injury or death!
-  **WARNING!** When installing this ladder treestand you must bounce on the first rung to set the ladder into the ground prior to attempting to climb any higher. Failure to follow these instructions may result in serious injury or death!
-  **WARNING!** You must check every ladder section connection every time you use the stand before you leave the ground. The sections should be connected securely using the provided u-brackets and bolts which add support and ensure proper connection. If you find that the ladder sections are separating, or if any of the u-brackets or bolts are not properly attached, **DO NOT USE** the treestand. Failure to follow these instructions may result in serious injury or death!
-  **WARNING!** You must check the ground under the treestand to make sure it is firm and level. Sloping ground or uneven surfaces (e.g., one foot on a rock) can cause your ladder to tilt or shift off the tree as you climb. Failure to follow these instructions may result in serious injury or death!
-  **WARNING!** You must maintain three (3) points-of-contact when climbing the ladder (i.e., two feet-one hand, two hands-one foot). Failure to follow these instructions may result in serious injury or death!
-  **WARNING!** You must always lean forward as you climb and attach your full-body fall arrest harness to the tree before securing the platform to the tree and stepping onto the standing platform. Failure to follow these instructions may result in serious injury or death!
-  **WARNING!** Always have a second adult present or at least accessible by cell phone or other means when using this product. The ability to get help quickly may save your life in the event of a fall. A good non-slip safety boot is important for your safety. Be especially careful that bootlaces do not get hooked on the ladder stand (tuck shoelaces into boot before climbing). Failure to follow these instructions may result in serious injury or death!

Warnings

FULL-BODY FALL ARREST HARNESS SYSTEM (FAS)

One (1) full-body fall arrest harness has been included with this product for your use. This full-body fall arrest harness has been designed to keep you from experiencing a fall. Remember, the most important part of your hunt is returning home to your family safe and sound.

READ THE FULL-BODY FALL ARREST HARNESS MANUAL CAREFULLY AND FOLLOW ALL THE INSTRUCTIONS! YOUR NEW FULL-BODY FALL ARREST HARNESS IS DESIGNED FOR A MAXIMUM CAPACITY OF 300 POUNDS (136kg). ADDITIONALLY YOUR NEW FULL-BODY FALL ARREST HARNESS MUST BE REPLACED AFTER THREE (3) YEARS OF SERVICE! REPLACE YOUR HARNESS IMMEDIATELY SHOULD YOU EXPERIENCE A FALL WHILE WEARING IT.







WARNING! Not to use without a Full Body Harness (Fall Arrest System) that meets the requirements of Test Method F2337. Use only the full-body fall arrest harness that has been tested by a third party testing laboratory to meet or exceed industry standards and is provided with this product.

NOTE: You must store your full-body harness out of direct sunlight and out of any other harsh environmental conditions that may adversely affect its performance. Failure to follow these instructions may result in serious injury or death! Read and understand the manufacturer's warnings, expiration date and instructions on how to use and how to properly adjust the harness.



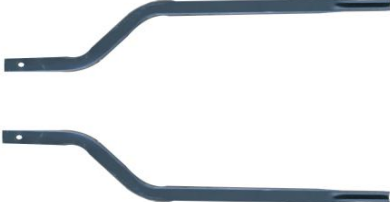

Tools Required (Provided)

1	Wrench (2 pcs)	
---	-------------------	--



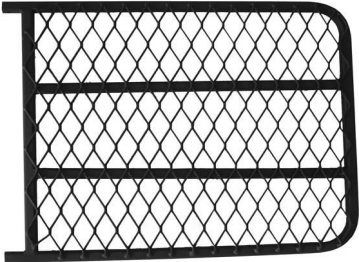

Parts List

1	Tree Brace		Qty 1
2	Left Bending Bar		Qty 1
3	Right Bending Bar		Qty 1
4	Shooting Rail Support Bar		Qty 2
5	Shooting Rail		Qty 1
6	Ladder Connect Bar		Qty 2

Parts List

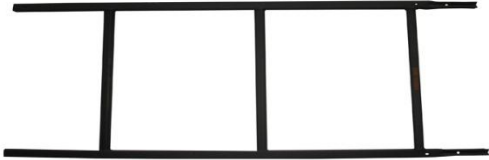
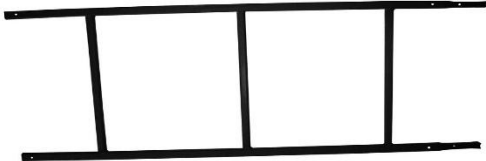
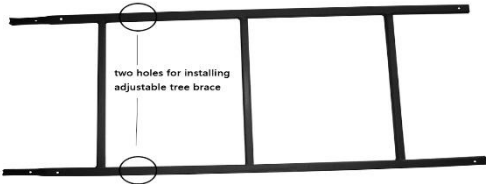
7	Foot Rest		Qty 1
8	Standing Platform		Qty 1
9	Ladder Brace		Qty 2
10	Seat & Backrest Frame		Qty 1
11	Seat Support Frame w/Tree V Brace		Qty 1
12	Seat Spreader Tool		Qty 2

Parts List

13	#4 Ladder Section		Qty 1
14	#3 Ladder Section		Qty 1
15	#2 Ladder Section		Qty 1
16	#1 Ladder Section		Qty 1
17	Adjustable Tree Brace		Qty 1
18	Adjustable Tree Brace Mount		Qty 1
19	U-Bracket		Qty 8

Parts List

20	Left Armrest		Qty 1
21	Right Armrest		Qty 1
22	Plastic Shelf		Qty 1
23	Stabilizer Strap		Qty 2
24	Ratchet Strap		Qty 2
25	Adjustable Tree Brace Cam Buckle Strap		Qty 1
26	Yellow Tension Strap		Qty 1

Parts List

27	Full-Body Fall Arrest Harness (FAS) with Instruction Manual (Meets Requirements of F2337)		Qty 1
----	---	---	----------

Hardware

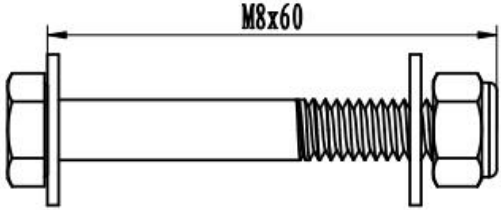
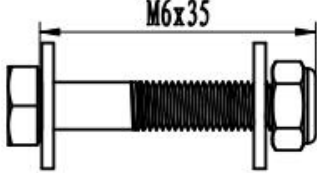
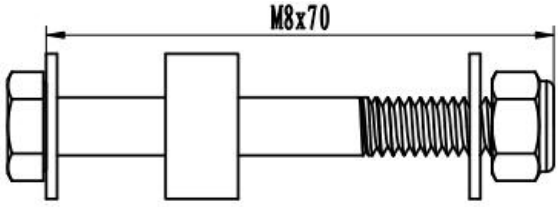
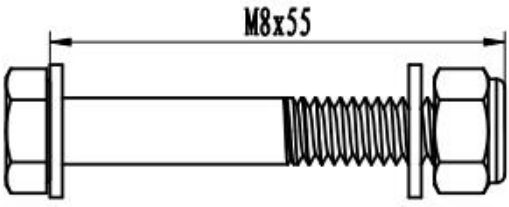
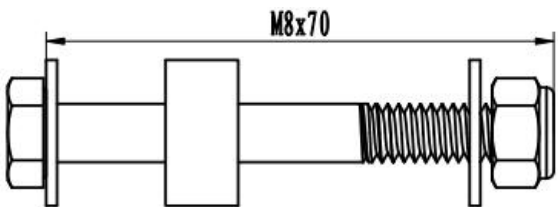
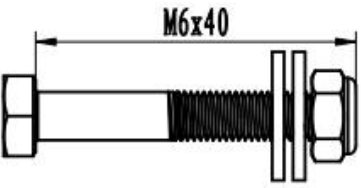
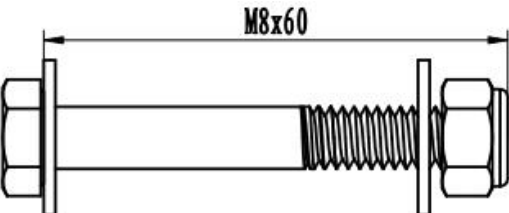
Step 1	M8X60 (with 2 Steel washers and 1 Locknut)		Qty 4
Step 2	M6X35 (with 2 Steel washers and 1 Locknut)		Qty 2
Step 3	M8X70 (with 2 Nylon washers, 1 Thicker Nylon Washer and 1 Locknut)		Qty 2
Step 4	M8X55 (with 2 Steel washers and 1 Locknut)		Qty 4
Step 5	M8X70 (with 2 Nylon washers, 1 Thicker Nylon Washer and 1 Locknut)		Qty 2
Step 6	M6X40 (with 2 Steel washers and 1 Locknut)		Qty 4
Step 7	M8X60 (with 2 Steel washers and 1 Locknut)		Qty 2

Hardware

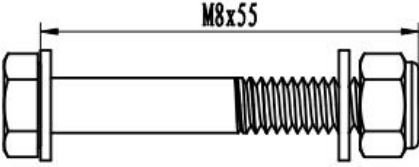
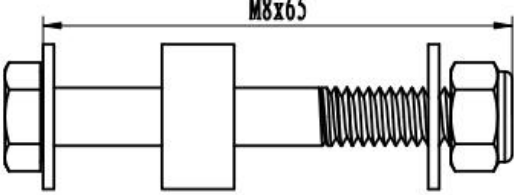
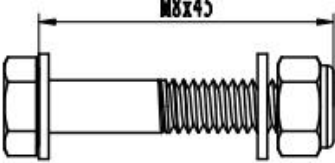
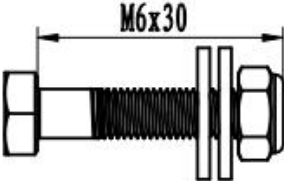
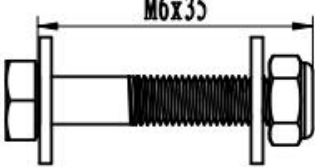
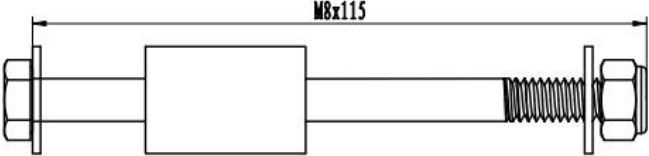
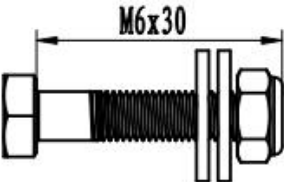
Step 8	M8X55 (with 2 Steel washers and 1 Locknut)		Qty 2
Step 9	M8X65 (with 2 Steel washers, 1 Thicker Nylon washer and 1 Locknut)		Qty 2
Step 10	M8X45 (with 2 Steel washers and 1 Locknut)		Qty 2
Step 11	M6X30 (with 2 Steel washers and 1 Locknut)		Qty 8
Step 12	M6X35 (with 2 Steel washers and 1 Locknut)		Qty 2
Step 13	M8X115 (with 2 Steel washers, 1 Thicker Nylon washer and 1 Locknut)		Qty 2
Step 14	M6X30 (with 2 Steel washers and 1 Locknut)		Qty 2

Hardware

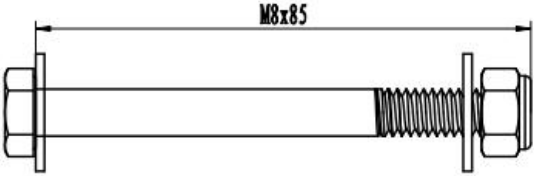
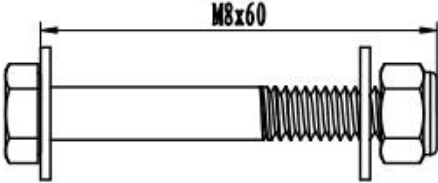
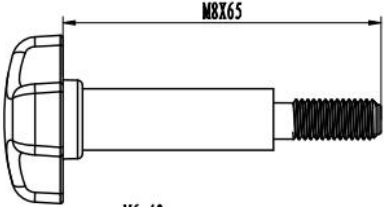
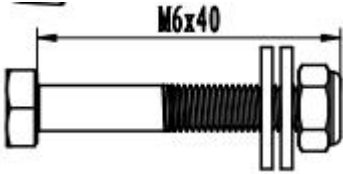
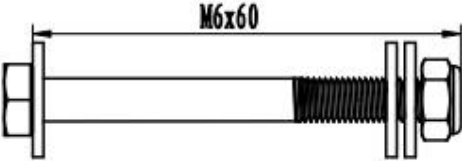
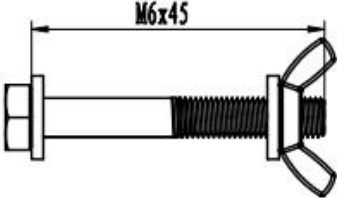
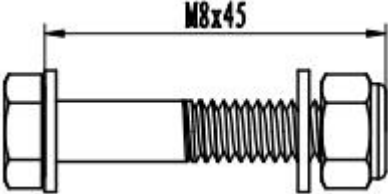
<p>Step 15</p>	<p>M8X85 (with 2 Steel washers, and 1 Locknut)</p>		<p>Qty 2</p>
<p>Step 16</p>	<p>M8X60 (with 2 Steel washers, and 1 Locknut)</p>		<p>Qty 2</p>
<p>Step 17</p>	<p>Hand Wheel (M8X65) with black PVC tube</p>		<p>Qty 2</p>
<p>Step 18</p>	<p>M6X40 (with 2 Steel washers and 1 Locknut)</p>		<p>Qty 12</p>
<p>Step 19</p>	<p>M6X60 (with 3 Nylon washers and 1 Locknut)</p>		<p>Qty 2</p>
<p>Step 20</p>	<p>M6X45 (with 2 nylon washers and 1 wing nut)</p>		<p>Qty 1</p>
<p>Step 21</p>	<p>M8X45 (with 2 Steel washers and 1 Locknut)</p>		<p>Qty 2</p>

Product Diagram

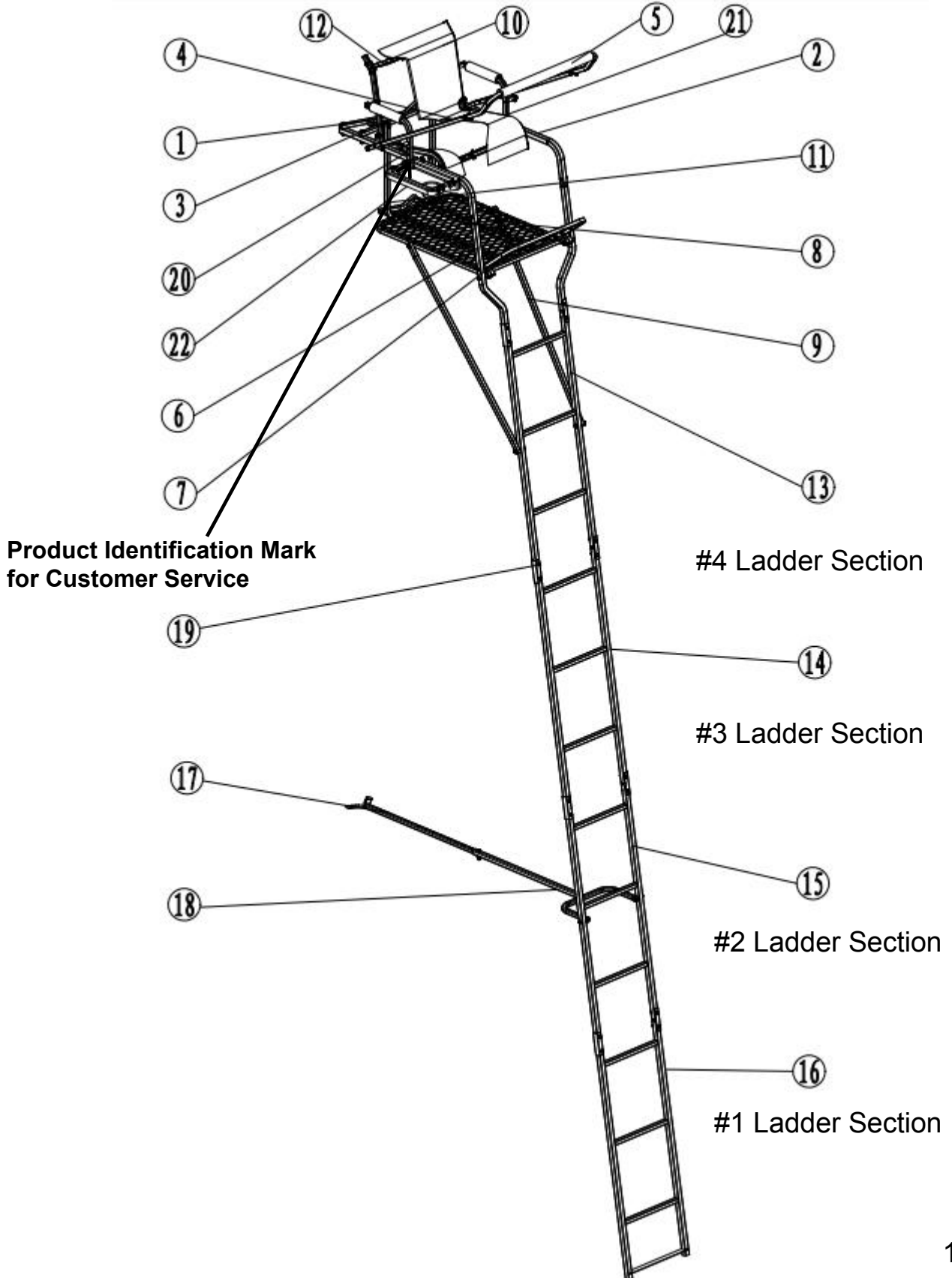

Assembly Instructions

⚠ WARNING: Do not overtighten the hardware in assembly instructions. Overtightening can lead to structural damage and may negatively affect the performance of your stand. Failure to follow these instructions may result in serious injury or death!

Step 1:

Locate Tree Brace (#1), Left Bending Bar (#2) and Right Bending Bar (#3). Install Tree Brace (#1) onto the Left Bending Bar (#2) and Right Bending Bar (#3) using four (4) M8x60 Bolts, eight (8) Steel Washers and four (4) Locknuts as shown in Figure 1. Securely tighten bolts.

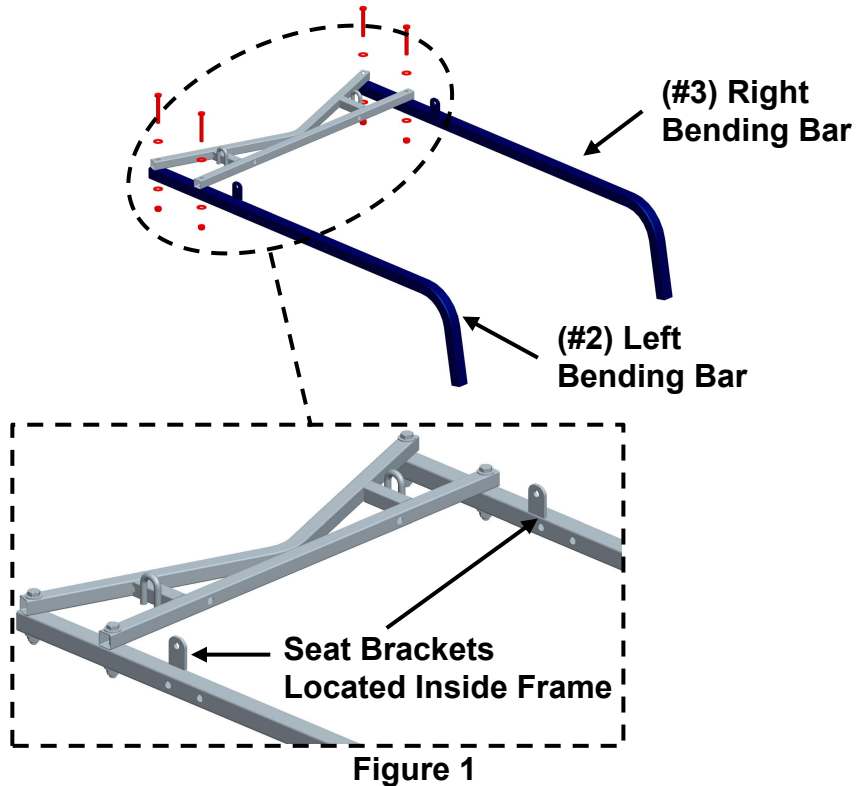

Install Tree Brace/Left Bending Bar/Right Bending Bar

Step 2:

Locate two Ladder Connect Bars (#6). Install the Ladder Connect Bar (#6) onto Left Bending Bar (#2) and Right Bending Bar (#3) using two (2) M6x35 Bolts, four (4) Steel Washers and two (2) Locknuts as shown in Figure 2. Securely tighten bolts.

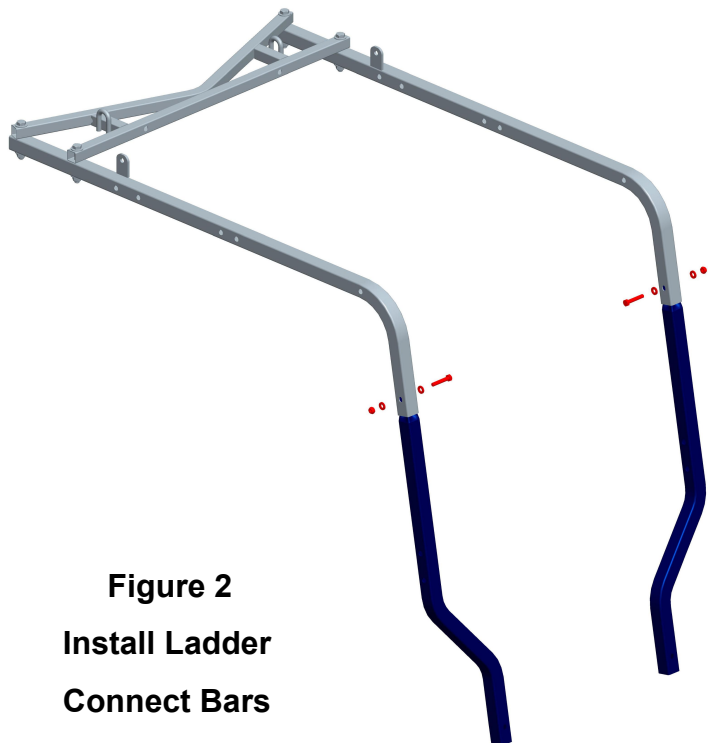

Figure 2
Install Ladder
Connect Bars

Assembly Instructions

Step 3:

Locate Standing Platform (#8). Install the front of Standing Platform (#8) onto the Ladder Connect Bars (#6) using two (2) M8x70 Bolts, four (4) Nylon Washers, two(2) thicker Nylon Washers and two (2) Locknuts as shown in Figure 3. Securely tighten bolts.

Note: Please place one thicker Nylon Washer between the Standing Platform and the Ladder Connect Bar.

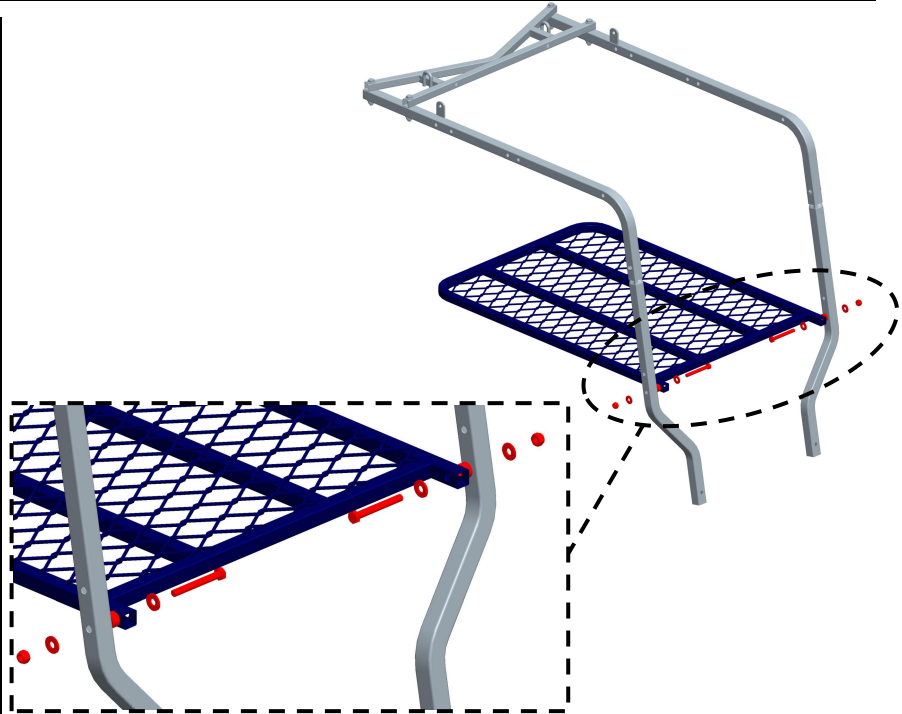

Figure 3

Install Standing Platform to Ladder Connect Bars

Step 4:

Locate Seat Support Frame W/Tree V Brace (#11). Install the Seat Support Frame W/Tree V Brace (#11) onto the Standing Platform (#8) and Tree Brace(#1) using four (4) M8x55 Bolts, eight (8) Steel Washers and four (4) Locknuts as shown in Figure 4. Securely tighten bolts.

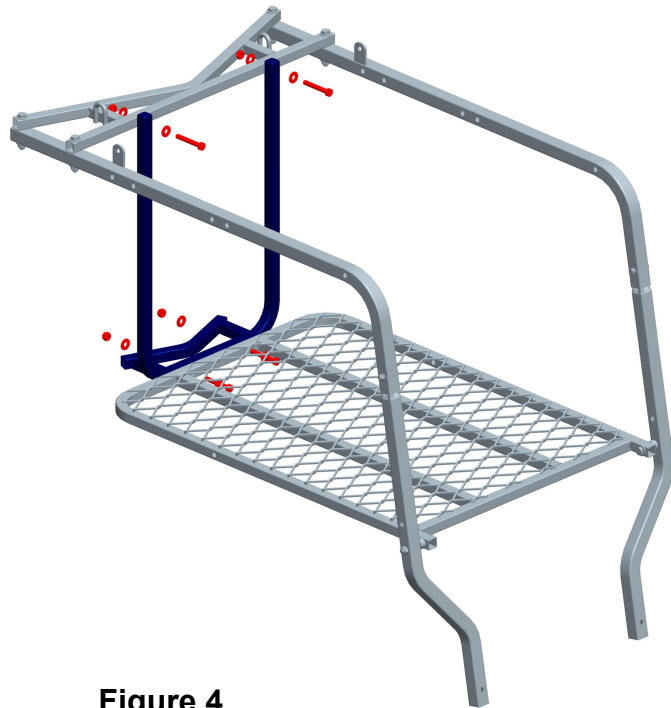

Figure 4

Install Seat Support Frame W/Tree V Brace

Assembly Instructions

Step 5:

Locate Foot Rest (#7). Install the Foot Rest (#7) onto the two Ladder Connect Bars (#6) using two (2) M8x70 Bolts, four (4) Nylon Washers, two(2) Thicker Nylon Washers and two (2) Locknuts as shown in Figure 5. Securely tighten bolts.

Note: Place one thicker Nylon Washer between the Foot Rest and the Ladder Connect Bar.

! WARNING: Never step or stand on Foot Rest!



Figure 5

Install Foot Rest

Step 6:

Locate #4 Ladder Section (#13) and two U-Brackets (#19). Slip the crimped end of #4 Ladder Section (#13) into the Ladder Connect Bars (#6) and secure with two U-Brackets (#19) using four (4) M6x40 Bolts, eight (8) Steel Washers and four (4) Locknuts as shown in Figure 7. Securely tighten bolts.

! WARNING: U-Brackets are required and must be used to provide support for the attachment points between the ladder sections. Bolts must be threaded through them on both sides of the ladder section. DO NOT omit U-Brackets. Failure to properly use the U-Brackets could lead to serious injury or death.

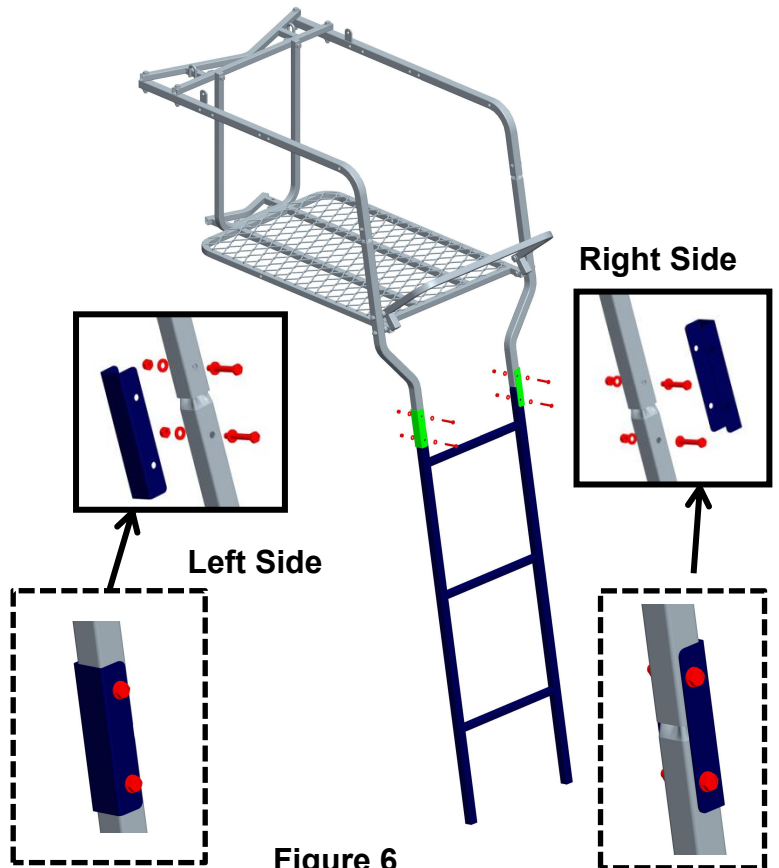

Figure 6

Install #4 Ladder Section

Assembly Instructions

Step 7:

Locate two Ladder Braces (#9).

Install one end of Ladder Braces (#9) onto the #4 Ladder Section (#13) using two (2) M8x60 Bolts, four (4) Steel Washers and two (2) Locknuts as shown in Figure 7.

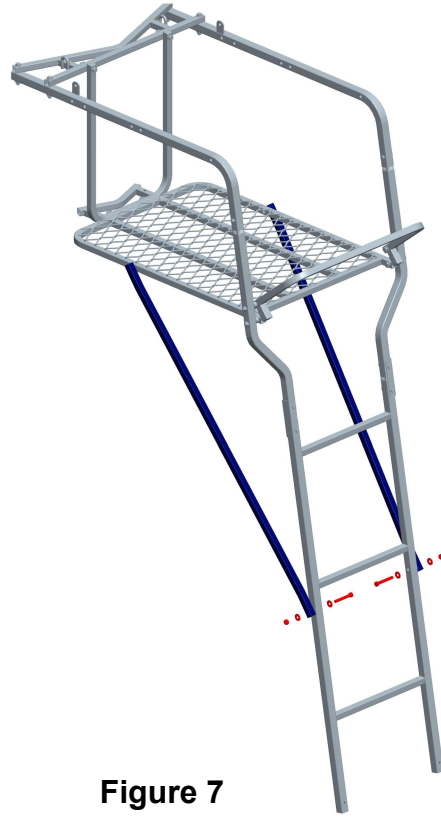

Figure 7

Install Ladder Brace to Ladder Section

Step 8:

Install another end of Ladder Braces (#9) onto Standing Platform (#8) using two (2) M8x55 Bolts, four (4) Steel Washers and two (2) Locknuts as shown in Figure 8. Securely tighten bolts on both ends of Ladder Braces.

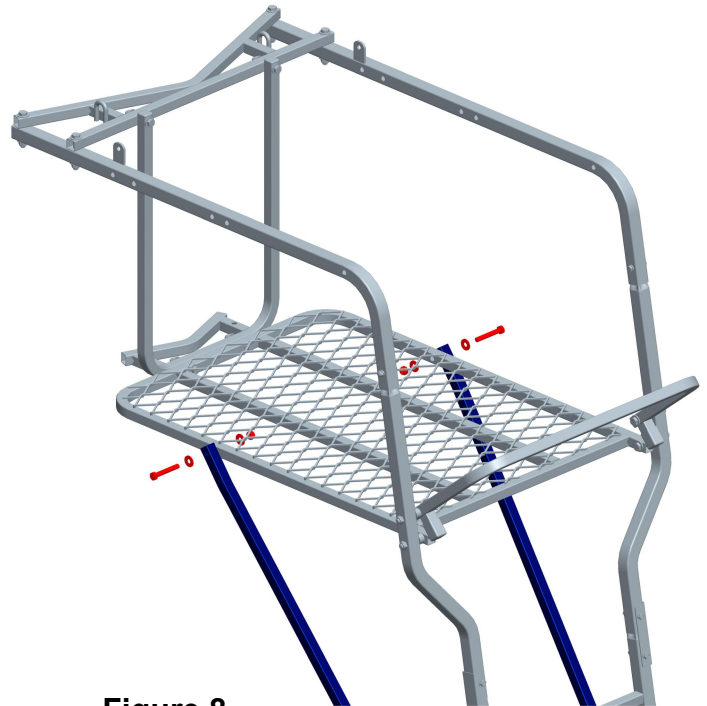

Figure 8

Install Ladder Braces to Standing Platform

Assembly Instructions

Step 9:

Locate Seat & Backrest Frame (#10).

Install the Seat & Backrest Frame (#10) onto Left Bending Bar (#2) and Right Bending Bar (#3) using two (2) M8x65 Bolts, four (4) Steel Washers, two (2) thicker Nylon Washers and two (2) Locknuts as shown in Figure 9. Securely tighten bolts noting seat is designed to rotate up and down.

Note: Please place the Nylon Washer between the Seat & Backrest Frame and the Bending Bar.

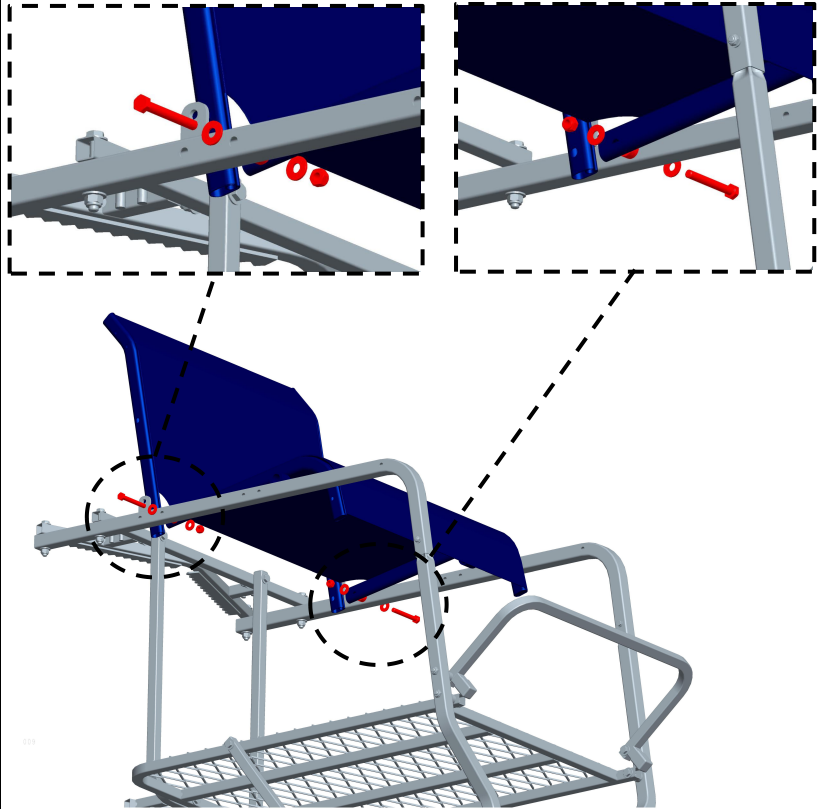

Figure 9
Install Seat & Backrest Frame

Step 10:

Install the Seat & Backrest Frame (#10) onto Bending Bar Tab using two (2) M8x45 Bolts, four (4) Steel Washers and two (2) Locknuts as shown in Figure 10. Securely tighten bolts.



Figure 10
Install Seat & Backrest Frame

Assembly Instructions

Step 11:

Locate two (2) Seat Spreader Tools (#12)

Install two (2) Seat Spreader Tools (#12) onto Seat & Backrest Frame (#10) using eight (8) M6x30 Bolts, sixteen (16) Steel Washers and eight (8) Locknuts as shown in Figure 11. Securely tighten bolts.

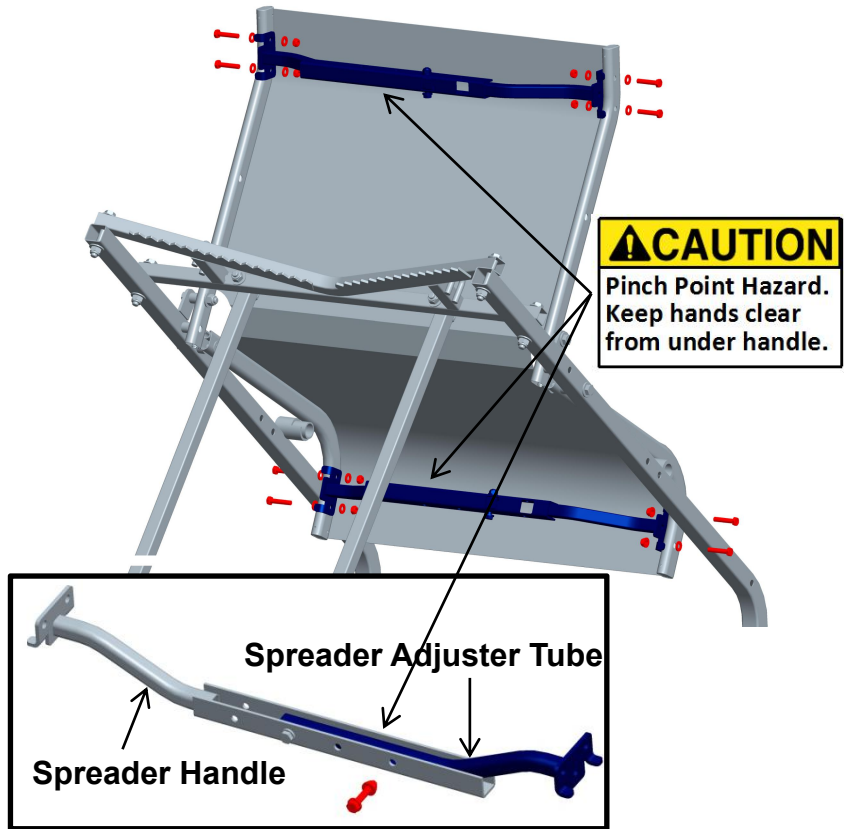

Figure 11

Install Seat Spreader Tool

Step 12:

Close two spreader tools and secure with two (2) M6x35 Bolt, four (4) Steel Washers and two (2) Locknut as shown in Figure 12. Securely tighten bolts.

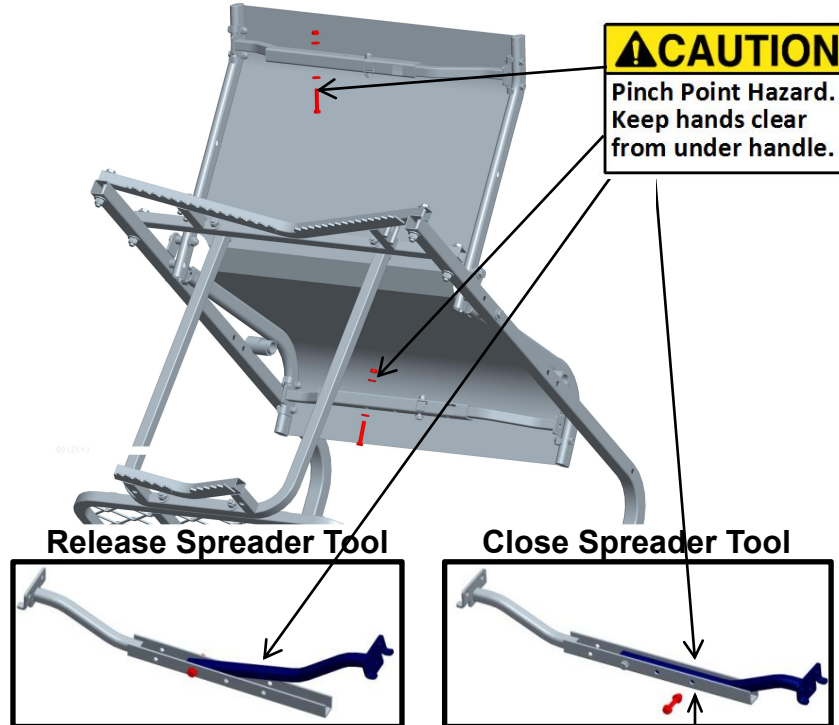

Figure 12 Close Spreader Tool

Assembly Instructions

Step 13:

Locate two Shooting Rail Support Bars (#4). Install the Shooting Rail Support Bars (#4) onto Left Bending Bar (#2) and Right Bending Bar (#3) using two (2) M8x115 Bolts, four (4) Steel Washers, two (2) Thick Nylon Washers and two (2) Locknuts as shown in Figure 13. Securely tighten bolts noting shooting rail is designed to rotate up and down.

Note: Please place one Thick Nylon Washer between the Shooting Rail Support Bar and the Platform Connect Bar.

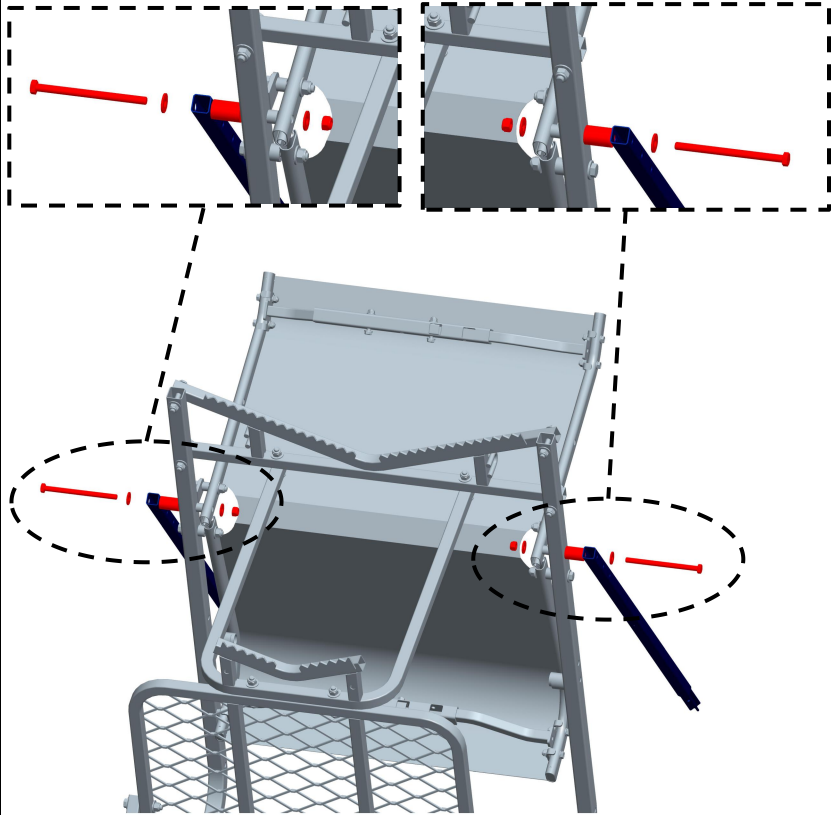

Figure 13

Install Shooting Rail Support Bars

Step 14:

Locate Shooting Rail (#5). Install the Shooting Rail (#5) onto the Shooting Rail Support Bars (#4) using two (2) M6x30 Bolts, four (4) Steel Washers and two (2) Locknuts as shown in Figure 14. Securely tighten bolts.

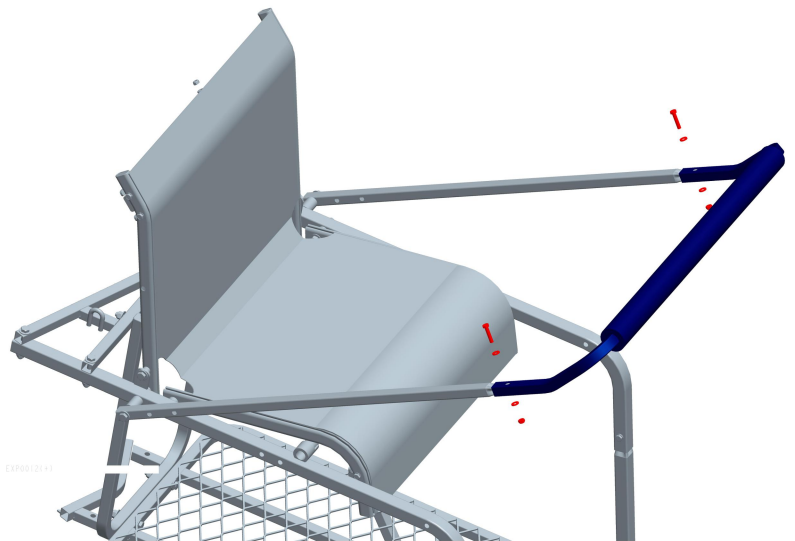

Figure 14

Install Shooting Rail

Assembly Instructions

Step 15:

Locate Left Armrest(#20) and Right Armrest(#21).

Install two Armrest to the Backrest using two(2) M8x85 Bolts, four(4) Steel Washers and two(2) Locknuts as shown in Figure 15. Securely tighten bolts.

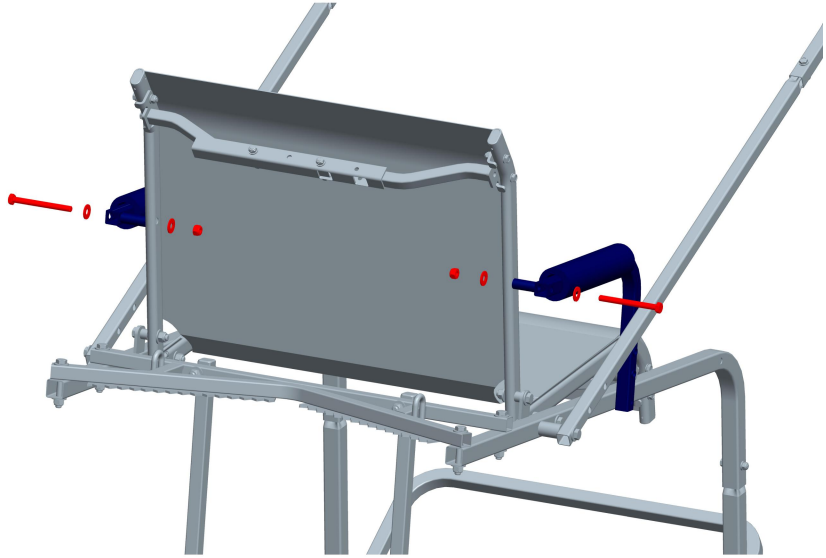

Figure 15
Install Armrest

Step 16:

Install two Armrest to the Bending Bars using two(2) M8x60 Bolts, four(4) Steel Washers and two(2) Locknuts as shown in Figure 16. Securely tighten bolts.

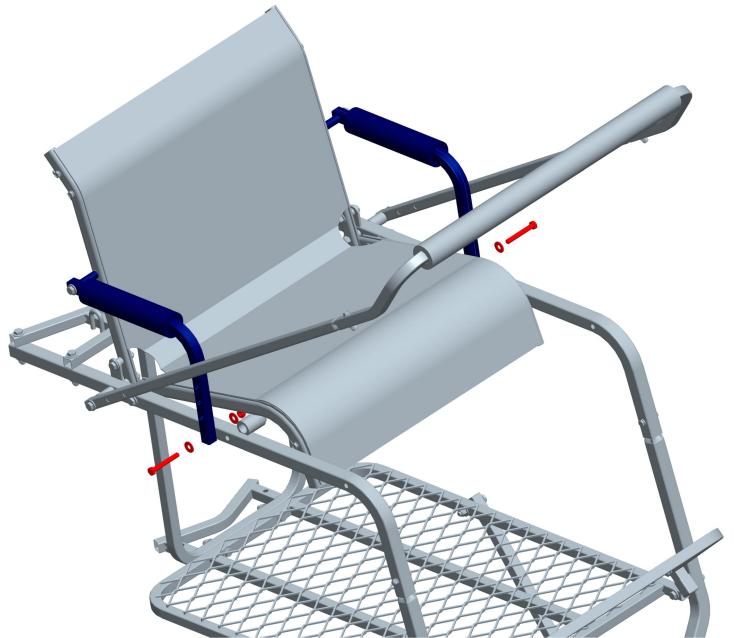

Figure 16
Install Armrest

Assembly Instructions

Step 17:

Locate two M8x65 Hand Wheels, bolting them on the Left Armrest (#20) and Right Armrest(#21) as shown in Figure 17. These two M8x65 Hand Wheels are used for Shooting Rail support. Securely tighten Hand Wheels.

Note: Shooting Rail height can be adjusted by bolting Hand Wheels on 3 different holes on the Arm Rest Bars. Always make sure both Hand Wheels are at same level so Shooting Rail contacts both Hand Wheels evenly.

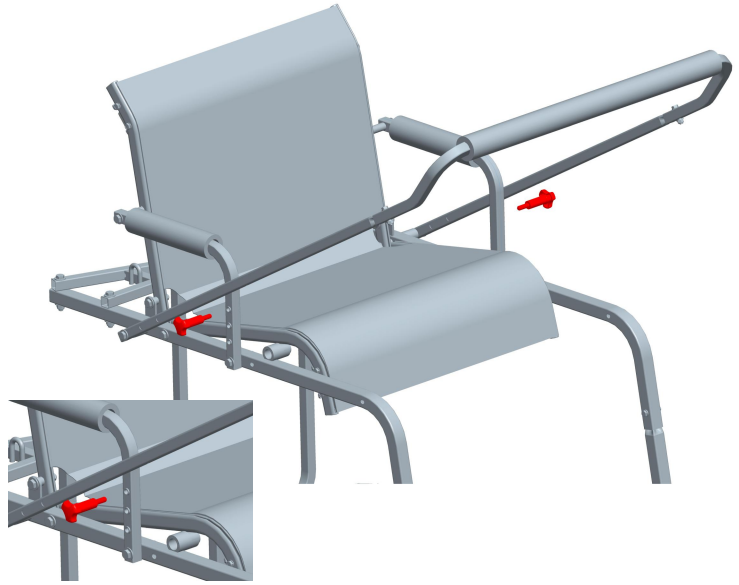

Figure 17

Install Hand Wheel for Shooting Rail Support

Step 18:

Locate #3 Ladder Sections (#14). Slip the male end of the #3 Ladder Section (#14) into the female end of the #4 Ladder Section (#13) first; Then secure 3 Ladder Sections with two U-Brackets (#19) using four (4) M6x40 Bolts, eight (8) Steel Washers and four (4) Locknuts as shown in Figure 18.

Repeat this step for remaining two ladder section from #2 to #1.



WARNING: U-Brackets are required and must be used to provide support for the attachment points between the ladder sections. Bolts must be threaded through them on both sides of the ladder section. DO NOT omit U-Brackets. Failure to properly use the U-Brackets could lead to serious injury or death.

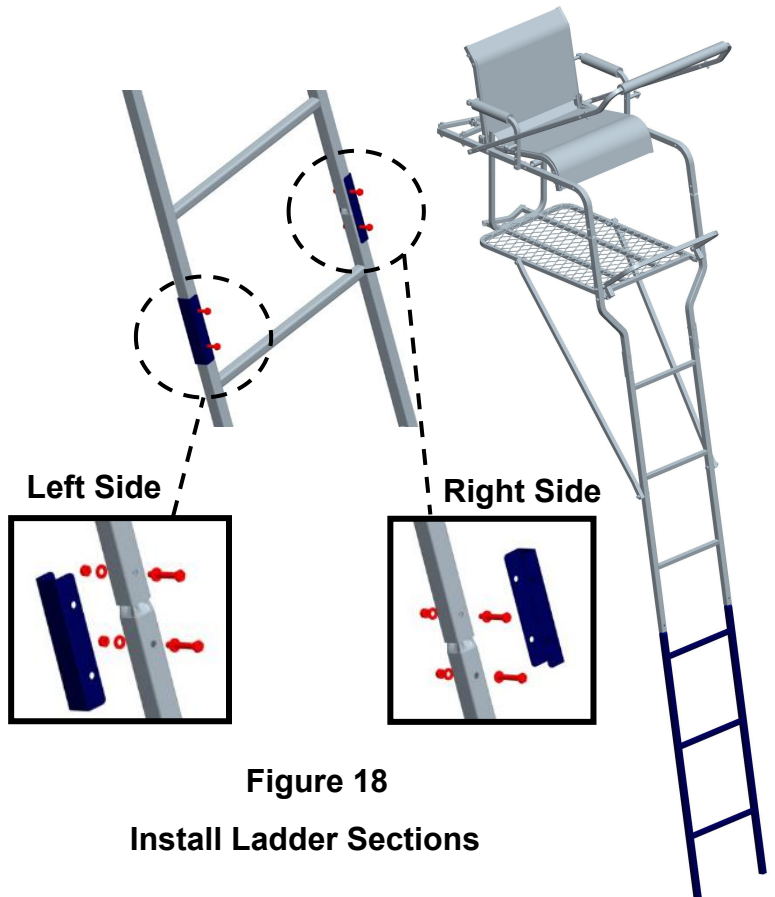

Figure 18

Install Ladder Sections

Assembly Instructions

Step 19:

Locate Adjustable Tree Brace Mount (#18). Install the Adjustable Tree Brace Mount (#18) onto the #2 Ladder Section (#15) using two (2) M6x60 Bolts, six (6) Nylon Washers and two (2) Locknuts as shown in Figure 19. Securely tighten bolts.

Note: Please place one Nylon Washers between the Adjustable Tree Brace Mount and the #2 Ladder Section each side.



Figure 19
Install Adjustable Tree Brace Mount

Step 20:

Locate Adjustable Tree Brace (#17). Slip the Adjustable Tree Brace (#17) into the Adjustable Tree Brace Mount (#18) and secure them using one (1) M6x45 Bolts, two (2) Nylon Washers and one (1) Wing Nut as shown in Figure 20. Securely tighten bolt.

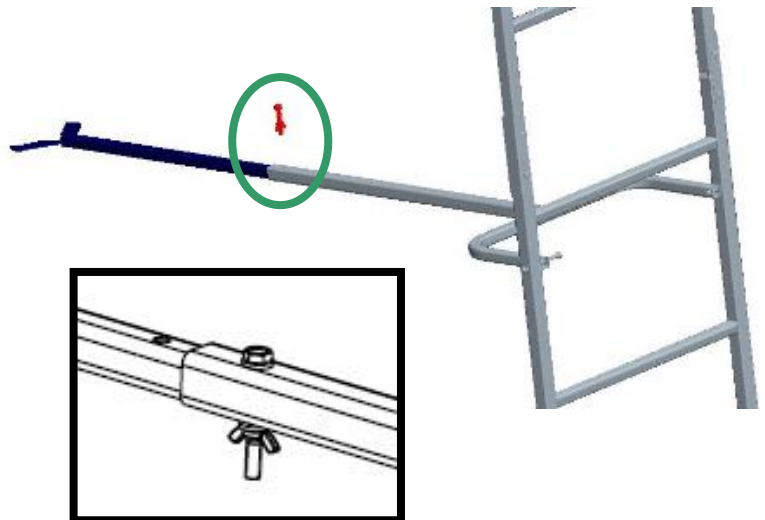

Figure 20
Install Adjustable Tree Brace

⚠ WARNING: Adjustable Tree Brace, Tree Brace and Bolt with Wing Nut must be installed. DO NOT omit these components. Failure to properly use these parts could lead to serious injury or death.

Assembly Instructions

Step 21:

Locate Plastic Shelf (#22). Install the Plastic Shelf(#22) onto the Bending Bar(Either Right or Left Side) using two (2) M8x45 Bolts, four (4) Steel Washers and two (2) Locknuts as shown in Figure 21. Securely tighten bolts.

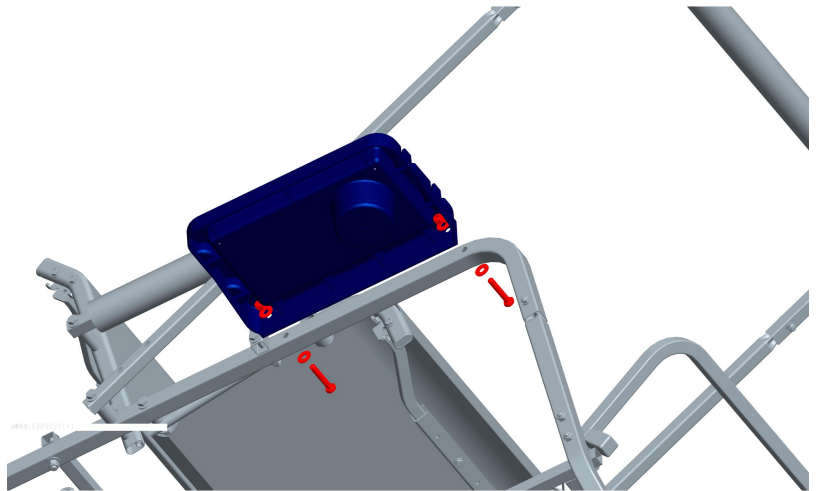

Figure 21
Install Plastic Shelf

Installation Instructions

SELECTING A SAFE TREE:



TREESTAND MINIMUM AND MAXIMUM TREE SIZE: 9 – 24” DIAMETER!

Never use treestand on a dead, leaning, diseased, loose barked tree, tree with excessive vines or on utility pole or any other man-made structure.

Never use on trees that contain nails, screws, or other sharp objects that may cut, sever, or puncture strap webbing or cables!

Never rely on a tree branch for support!

Failure to follow these instructions can lead to serious injury or death!

- Select a healthy straight tree that fits within size limits larger than 9-inches in diameter and smaller than 24-inches in diameter at attachment height.
- Always thoroughly inspect tree from all sides before installing product.
- Be sure treestand platform is level. Tree must not lean or have any irregular shapes.
- Do not select a tree with vines or limbs below your desired hunting height.
- Never attach treestand to limbs! Always attach treestand to main trunk of tree.
- Never use treestand on trees with wet, icy, slippery, loose or scaly bark.

PRACTICE AND BECOME FAMILIAR WITH PRODUCT AT GROUND LEVEL:

Always practice attaching/detaching, adjusting and using treestand and full body harness at ground level prior to using at elevated positions.

Prior to using treestand and full body harness at elevated positions for first use of each season, test operation and use at ground level.

FULL BODY SAFETY HARNESS (FALL ARREST SYSTEM – FAS):



You must wear and use supplied 4 point full body harness when installing and using this treestand.

Always connect harness to tree as soon as possible and prior to stepping on the platform and always remain harness to tree until you leave platform.

Read and understand included Full Body Harness Instructions, Warnings, and watch safety video for instructions on using your full body harness.

Failure to follow these instructions can result in serious injury or death.

Refer to Full Body Harness (FAS) Instruction Manual supplied with this treestand for proper wear, adjustment, usage and maintenance.

THE REST OF THE INSTRUCTIONS IN THIS MANUAL REQUIRE YOU TO WEAR AND USE SUPPLIED 4 POINT FULL BODY HARNESS SUPPLIED WITH THIS TREESTAND.

Installation Instructions

SETTING UP THE GAME WINNER LADDER STAND ONTO THE TREE

! WARNING! STOP! Make sure that you are wearing your full-body fall arrest harness. Failure to follow these instructions may result in serious injury or death!

! WARNING! Prior to attempting to use this, or any other Game Winner product(s), you must take a moment and become familiar with its setup and installation at ground-level. You must practice installing, setting-up using and removing product(s) and full-body safety harness at ground-level prior to attempting to use it at heights above ground-level. Once you have become thoroughly knowledgeable and comfortable with this Game Winner product(s) setup, installation use and removal at ground-level, you're now ready to use it at heights above ground-level. Failure to follow these instructions may result in serious injury or death!

STEP 1:

Select a straight healthy tree that is larger than 9-inches in diameter and smaller than 24-inches in diameter at attachment height.

STEP 2:

Attach the two (2) Stabilizer Straps (#23) to both the left and right sides of the standing platform as shown in Figure 22. Attach by looping strap loop around back corner of standing platform tube and insert end of strap through strap loop. Pull tight so strap is secure on platform tube and positioned next to tree brace. Repeat for strap on other side of standing platform tube.

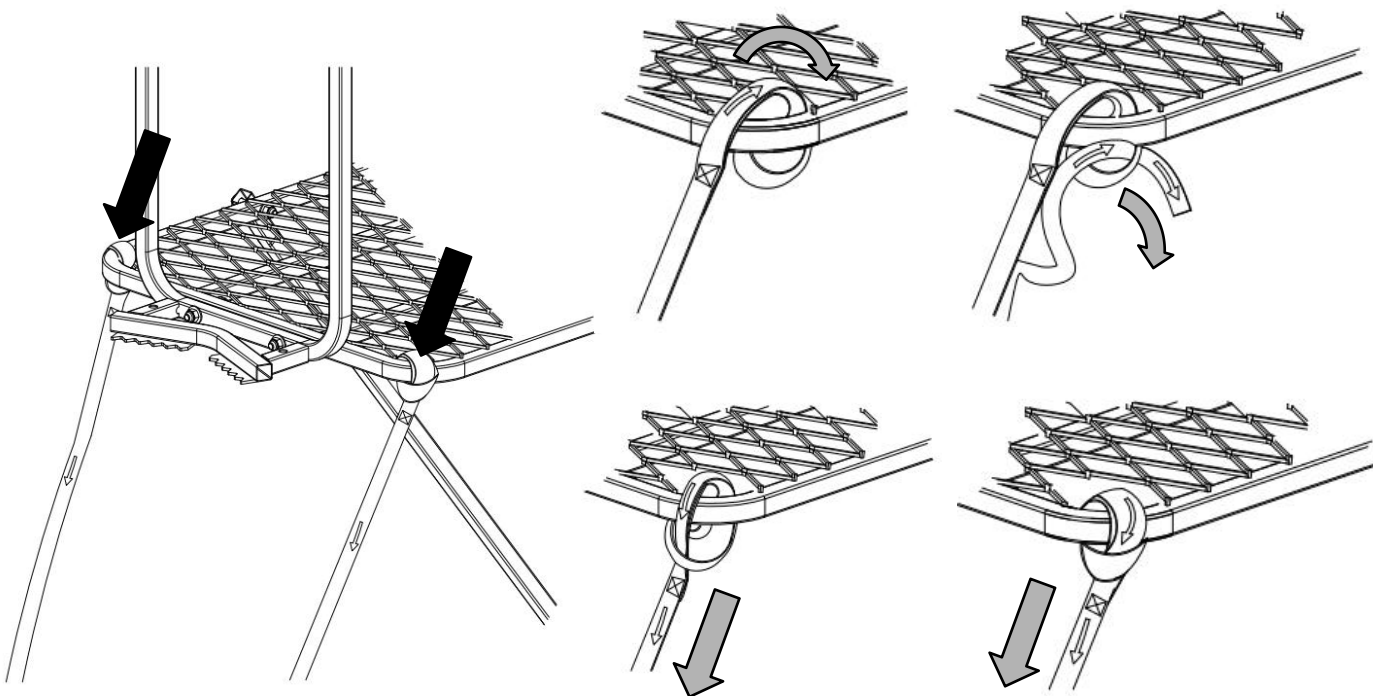

Figure 22

Install Stabilizer Straps

Installation Instructions

! WARNING! Make sure stabilizing straps do not contact tree teeth.

STEP 3:

Allow Straps to hang freely from the standing platform.

! WARNING! You must check the ground under the treestand to make sure it is firm and level. Sloping ground or uneven surfaces (e.g., one foot on a rock) can cause your ladder to tilt or shift off the tree as you climb. Prior to attempting to climb a ladder stand for the first time, make certain the feet of the bottom rung ladder section are firmly planted on solid, level ground. If they are not firmly planted on level ground, DO NOT climb the ladder. Failure to follow these instructions may result in serious injury or death!

! WARNING! Your Game Winner Ladder is designed, engineered and constructed in a manner that makes it a rugged piece of hunting equipment that will give you years of trouble-free service. This rugged-construction makes your Game Winner Ladder physically heavy. As such, you should never attempt to install this ladder by yourself. YOU MUST HAVE A MINIMUM OF THREE (3) ADULTS FOR THE SAFE ERECTION OF YOUR treestand. In addition to helping carry the heavier construction of the stand, the use of three people are required for set up. Failure to follow these instructions may result in serious injury or death!

STEP 4: You are now ready to lean your ladder stand up against the tree. Please note that it takes a minimum of three (3) adults to perform this operation. With the ladder stand laying flat on the ground in front of the tree, place the legs approximately 3' to 4' from the base of the tree.

STEP 5: Tip Ladder Up to Tree. Have one adult hold bottom of ladder while guiding/pulling stand with stabilizer straps while the other two adults raise ladder stand to tree shown in Figure 23. Have two adults lift platform and walk ladder stand up tree so ladder stand is in vertical position and teeth on Seat Support Frame are contacting tree. Once positioned against tree, step back from the tree and determine if the ladder stand's seating platform is level. If it is not level, move the legs of the lower ladder section closer or further from the tree (as appropriate) until the seating platform is leveled. Once level, always have one person step/bounce on bottom ladder rung to set ladder into ground.

Figure 23
Leaning Ladder
Stand Against
Tree

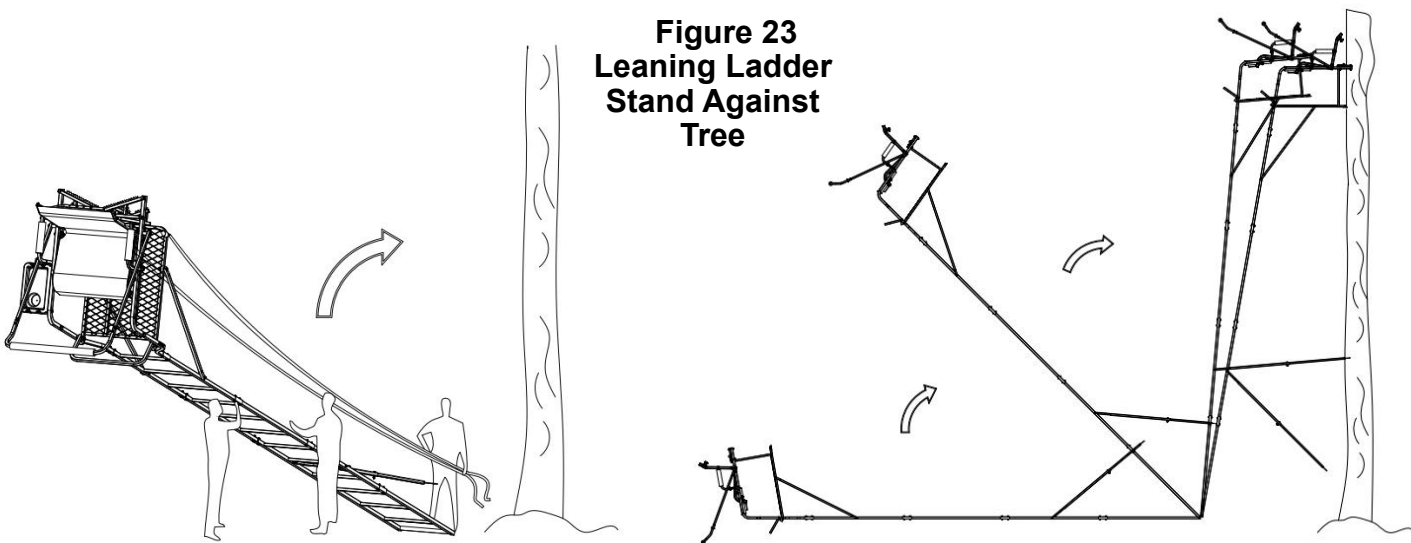

! WARNING! Always make sure platform is level! If platform is leaning forward, leaning back, leaning left or leaning right reposition treestand or select different tree.

Installation Instructions

STEP 6:

Once the ladder stand platform has been leveled, adjust tree brace assemblies by lengthening or shortening so they fit snugly against the tree trunk and provide rigid support to the ladder sections. Adjust the braces length so they are snug against the tree trunk. Secure brace with (1) M6x45mm bolt, (2) washers and wing nut shown in Figure 20. Once the adjustable tree brace is snug and the standing and seating platform are level, install the Adjustable Tree Brace Strap (#25) onto the adjustable tree brace to secure it to the tree trunk. To accomplish this, attach hook through hole on tree V and wrap strap around back of tree and attach other hook through hole on other side of tree V and pull strap tight. Adjustable tree brace and strap must be tight and secured to tree trunk shown in Figure 24.

Note: Strap and adjustable tree brace must be very tight and secured to tree!

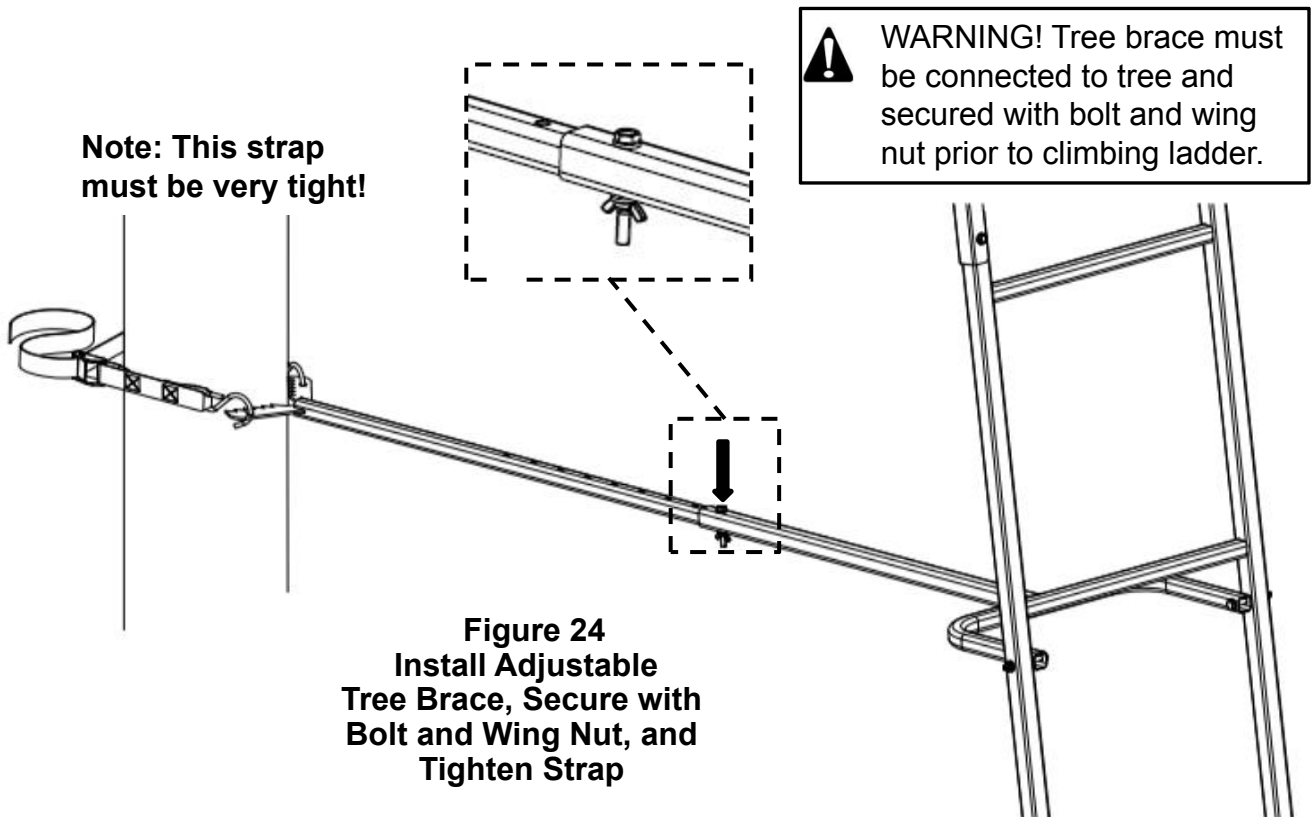

Installation Instructions

STEP 7: Now take the stabilizer straps and crisscross them behind the tree trunk so straps cross just below platform and pull them snug and tie them to a rung on the middle ladder section (or the highest rung you can safely reach from the ground) as shown in Figure 25.

! WARNING! Prior to climbing, make sure that all the ladder sections are securely connected with U-Brackets, tree braces are secure to tree (with bolt and strap), stabilizer straps are installed and the ladder assembly is solidly secured to the tree. Failure to follow these instructions may result in serious injury or death!

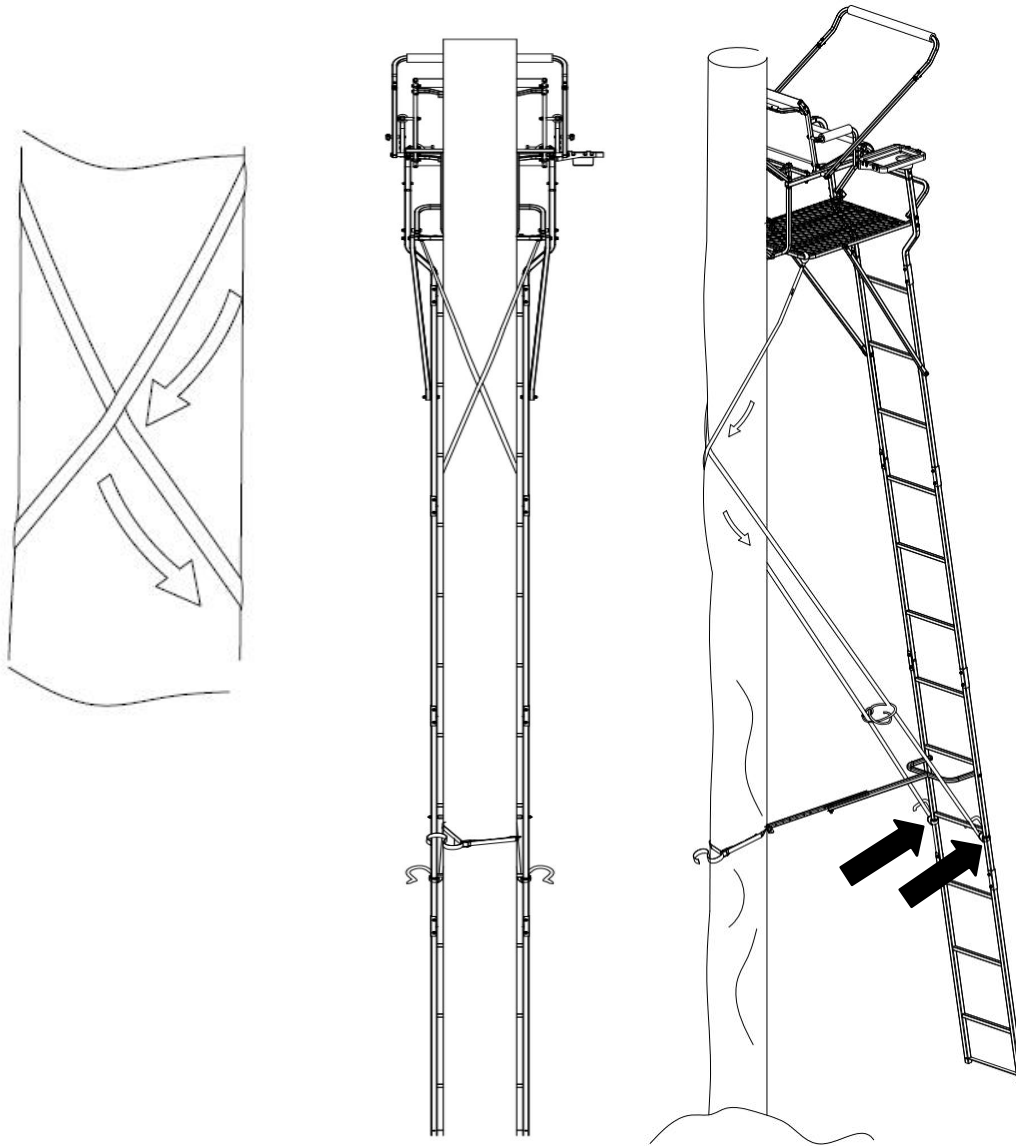

Figure 25
Stabilizer Straps
Installed

Installation Instructions

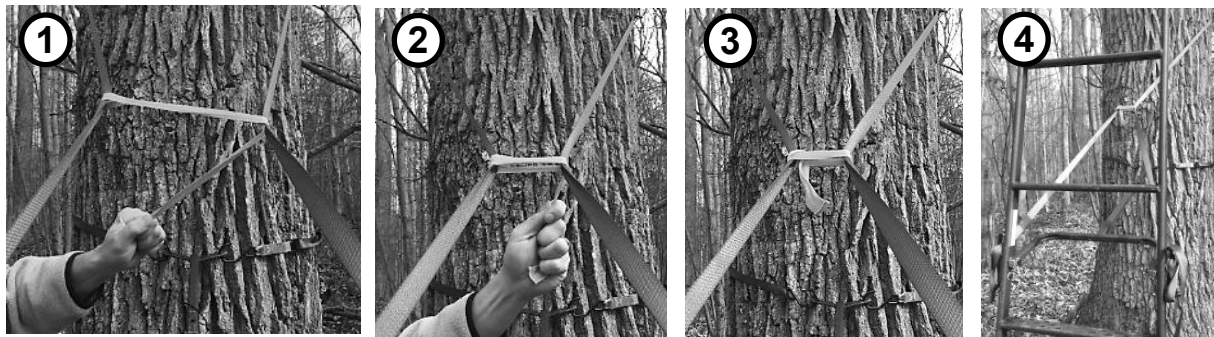

Figure 26

Connect Yellow Tension Strap

STEP 8: Wrap yellow tension strap (#26) around both stabilizer straps and pull tight drawing stabilizer straps together. Wrap tension strap around drawn stabilizer straps 3 to 4 times and tie off tension strap so it will not loosen (see Figure 26).

! **WARNING!** Prior to attempting to climb a ladder stand for the first time, make certain the feet of the bottom rung ladder section are firmly planted on solid, level ground. If they are not, firmly planted on level ground, **DO NOT** climb the ladder. With three (3) adults, lower the stand and find a suitable location to safely install the ladder stand. Failure to follow these instructions may result in serious injury or death!

! **WARNING!** When climbing to secure the ratchet strap, always have two (2) adults hold base of ladder steady against tree. Always lean forward when climbing to keep the stand centered and secure to the tree trunk. **DO NOT** lean backwards when climbing! Failure to follow these instructions may result in serious injury or death!

! **WARNING!** When climbing, always maintain three points of contact as you ascend (climb up) and while descending (climb down). Failure to maintain three points of contact puts the user at serious risk of bodily injury. Failure to follow these instructions will result in serious injury or death!

! **WARNING!** As you approach the top of the ladder, attach your full-body fall arrest harness tether to the tree trunk as soon as possible. After your tether has been attached to the tree, attach the ratchet straps to secure the top of the stand to the tree. **DO NOT** sit or stand on the standing platform until the ratchet straps have been securely fastened. Failure to follow these instructions may result in serious injury or death!

STEP 9a: With two (2) other adults holding the base of the ladder stand steady against tree (refer to Figure 27), climb to a height that allows you to safely attach your full-body fall arrest harness tether to the tree trunk as soon as possible.

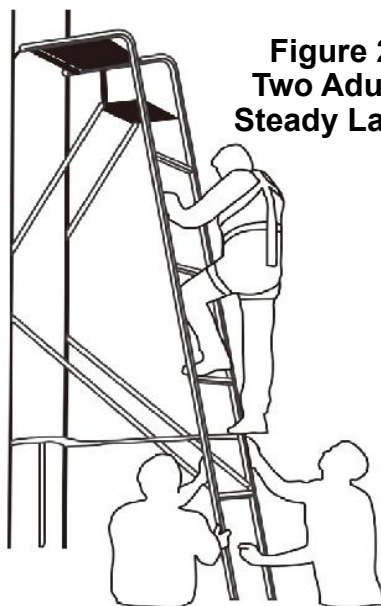

Figure 27
Two Adults
Steady Ladder

Installation Instructions

STEP 9b: After your tether has been attached to the tree trunk securing your position, attach the ratchet straps (#24) to secure the top of the stand to the tree. First, install upper ratchet strap (#24) by attaching hook onto loop (hook facing away from tree) on Tree Brace (#1) and wrap the strap around tree trunk and attach to loop (hook facing away from tree) on opposite side of Tree Brace as shown in Figure 28. Using ratchet, tighten strap so it is very tight. Install second lower ratchet strap (#24) by attaching hook through hole (hook faces down) on Seat Support Frame w/ Tree V Brace (#11) and wrap strap around tree trunk and attach hook to hole on opposite side of Tree V Brace as shown in Figure 28. Using ratchet, tighten strap so it is very tight.

NOTE: For ratchet threading instructions, refer to Figure 29. NEVER ATTEMPT TO THREAD A RATCHET ABOVE GROUND LEVEL.

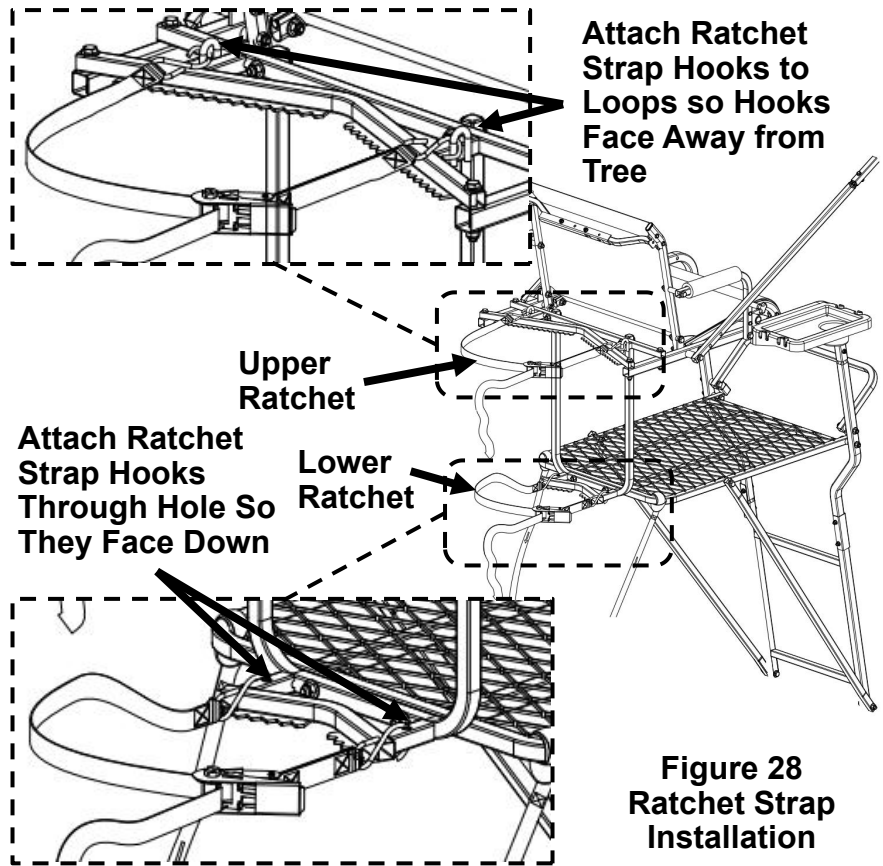

Figure 28
Ratchet Strap
Installation

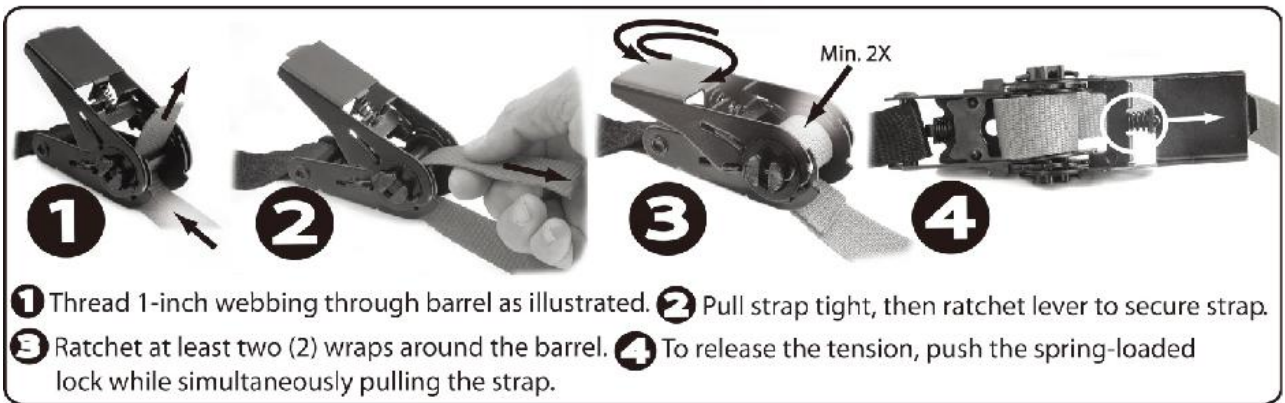

Figure 29 Threading Ratchet Strap

! WARNING! DO NOT use this, or any other Game Winner product(s) to climb utility poles, telephone poles, structural columns or any other man-made structures. Never use this or any other Game Winner product(s) around power generation (e.g., transformers, generators, substations, etc.) and/or power transmission equipment. Failure to follow these instructions may result in serious injury or death!

STEP 10: HUNTING: Once at height, always remain harnessed to the tree with your full body harness. Harnesses must be worn and attached to the tree at all times during a hunt, prior to ever stepping on the platform, and should not be removed until you begin your descent. Hunt safely. Wear and properly use your harness.

Before each use, inspect treestand and all safety devices for damage including but not limited to corrosion, cracks, deformity, bends, rot, wear, cuts or fraying and other damage to tree straps, crimps, hardware, platform, upright, seat, etc. Do not use if damage, wear, deterioration, vandalism, etc. is detected or suspected.

Before each use, do not climb ladder or use without having crossing straps attached tight, stabilizer bar attached to tree, bolt with wing nut installed and main ratchet straps attached shown in Figure 30.

Before climbing ladder, always check every ladder section connection to assure sections are not separating. If ladder sections are separating, do not use the stand.

Always maintain 3 points of contact when climbing up/down ladder and in/out of treestand.

Do not climb onto or use treestand with another person. This product is designed for and intended for only one person.

Always use hoist rope to pull up bow, crossbow, firearm, backpack or other gear only after being secured in treestand. Firearm, crossbow, and bow must be pulled up unloaded with firearm chamber open and muzzle down. Never climb with anything on your back.

Never rely on tree branch for support.

Do not jump, bounce, hop, rock back and forth, etc. on treestand.

Do not lean out or against treestand, armrest or shooting rail. Always stay centered on platform with minimal movement.

Always position safety harness tree strap with tether above your head so tether is minimized at all times.

Never allow tether strap to get under your chin or around your neck.

Hunt from ground when self-recovery/escape ability is absent. Do not stand on footrest or treestand seat.

Failure to follow these instructions can result in serious injury or death.

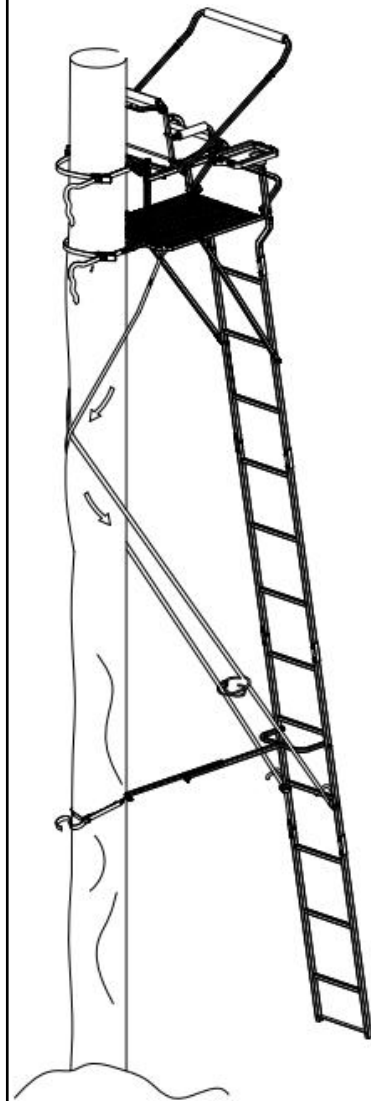





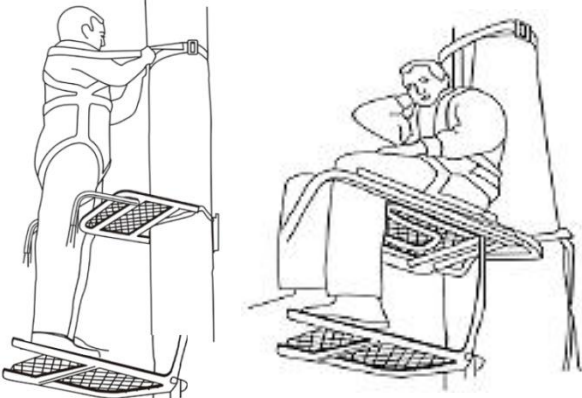

Figure 30
Tree Connection Points



WARNING!







- Never hunt out of a treestand at heights you are not completely comfortable. Depending on tree and conditions, choose minimum height that allows for safe and effective hunting.
- Never Hurry! While climbing, make slow, even movements and make sure you have proper 3 point contact with treestand every time you move.
- Always inform someone of hunting location, where treestand will be located, and expected duration of hunt.
- Always have second adult present or at least accessible by cell phone or other means when using treestand. Ability to get help quickly may save your life in event of a fall.
- Always take and use signal device (mobile phone, radio, whistle, signal flare or personal locating device (PLD)) when using this product. Always keep signal device on you and readily available at all times.

Usage

STEP	INSTRUCTION	IMAGE
1	<p>At ground level, put on full body harness following harness manufacturer's instructions. If you are not wearing harness, STOP and do not leave the ground.</p>	<div data-bbox="714 208 1332 369" style="border: 1px solid black; padding: 5px;">  <p>Read and understand included Full Body Harness Instructions, Warnings and watch safety video for instructions on using your Full Body Harness</p> </div>
2	<p>Climb ladder using 3-point climbing method while leaning forward. Before stepping onto platform, attach full body harness tether to tree with harness tree strap.</p> <div data-bbox="219 643 649 803" style="border: 1px solid black; padding: 5px; margin-top: 20px;">  <p>ALWAYS FOLLOW INCLUDED SAFETY HARNESS INSTRUCTION</p> </div>	<div data-bbox="714 401 1332 803" style="border: 1px solid black; padding: 5px;">  <p>Always maintain three points of contact when climbing ladder and entering or exiting platform. Always lean forward as you climb and attach harness to tree before securing platform to tree and stepping onto platform. Never grab seat as handle to get into or out of treestand. Never step onto platform without first being attached to tree with full body harness.</p> </div>
3	<p>Step onto platform and adjust harness tree strap above your head so tether is under tension when sitting.</p> <div data-bbox="219 996 649 1126" style="border: 1px solid black; padding: 5px; margin-top: 10px;">  <p>ALWAYS FOLLOW INCLUDED SAFETY HARNESS INSTRUCTION</p> </div> <p>You are now ready to hunt.</p>	
4	<p>Exit Treestand</p> <p>Face tree and step down on ladder. When both feet are on ladder step, detach full body harness from tree. Use 3 point climbing method while leaning forward to climb down ladder.</p>	<div data-bbox="714 1335 1332 1543" style="border: 1px solid black; padding: 5px;">  <p>When exiting, face tree and step down onto ladder. When both feet are on ladder step, lean forward and disconnect harness from tree. Then proceed to climb down ladder.</p> </div>









Removal Instructions

Removing Your Game Winner Ladder Stand

-  **WARNING! STOP!** Make sure that you are wearing your full-body fall arrest harness. Failure to follow these instructions may result in serious injury or death!
-  **WARNING!** When climbing to remove the ratchet straps, always have two (2) adults hold base of ladder steady. Always lean forward when climbing to keep the stand centered and secure to the tree trunk. **DO NOT** lean backwards when climbing! Failure to follow these instructions may result in serious injury or death!
-  **WARNING!** When climbing, always maintain three points of contact as you ascend (climb up) and while descending (climb down). Failure to maintain three points of contact puts the user at serious risk of bodily injury. Failure to follow these instructions will result in serious injury or death!
-  **WARNING!** As you approach the top of the ladder, attach your full-body fall arrest harness tether to the tree trunk as soon as possible. After your tether has been attached to the tree, remove the ratchet straps. Failure to follow these instructions may result in serious injury or death!
-  **WARNING!** Always keep crossing straps, stabilizer bar, and bolt with wing nut **ATTACHED** to tree! **Remove Last!** Failure to follow these instructions may result in serious injury or death!
-  **WARNING!** Never drop ladder stand out of tree as this may damage treestand. Always use three (3) adults to slowly lower stand to ground.

STEP 1: With three (3) adults reverse the installation instructions to remove your Game Winner Ladder.

Care and Maintenance

-  **WARNING!** Proper maintenance and inspection is required for this product. Thoroughly inspect this or any other Game Winner product(s) prior to use for signs of wear, rot, corrosion, cracks, fraying, deterioration and/or any other type of damage. DO NOT use this or any other Game Winner product(s) if they show evidence of wear, rot, corrosion, cracks, fraying, deterioration and/or any other type of damage. Failure to follow these instructions may result serious injury or death!
-  **WARNING!** DO NOT allow this product to be kept outdoors for more than two weeks (14 days). DO NOT expose this product for extended periods to direct sunlight, high wind, bad weather conditions, excessive heat or freezing temperatures. Exposure to such weather conditions can be unpredictable and can lead to damage of the product. Allowing a product to remain unattended may also result in damage to the product that could be caused by a variety of sources, including but not limited to tree growth vandals, animals or other sources. Inspect the product upon removal and prior to every installation and use.
-  **WARNING!** Do not remove, modify any portion or otherwise mechanically modify this product or its assemblies in any manner. Make certain that all parts are used in the assembly of this product. Parts are designed and tested to work together. Modification, additions, misuse, part omission or substitution shall immediately void your factory warranty and may result in serious injury or death! If you suspect a part(s) is missing and/or damaged, immediately contact Innopower Inc. at (949) 262-3416 for replacement of missing or defective parts. Never modify your stand in any way by making repairs, altering, omitting, adding or attaching anything to it. ALWAYS USE GENUINE FACTORY AUTHORIZED INNOPOWER INC. REPLACEMENT PARTS. USE OF ANY REPLACEMENT PARTS OTHER THAN GENUINE INNOPOWER INC. PARTS VOIDS YOUR WARRANTY AND RELIEVES INNOPOWER INC. OF ANY RESULTANT LIABILITIES AND MAY RESULT IN SERIOUS INJURY OR DEATH!
-  **WARNING!** Replace all hardware/cables/nuts/bolts/clips on your treestand if inspection reveals any damage, including but not limited to wear, rot, corrosion, cracks, fraying, deterioration and/or any other type of damage. Use only Game Winner replacement parts. The product is tested to be used only with genuine Game Winner parts. Use of any other parts, which are not genuine Game Winner parts, constitutes a modification to the product and could result in serious injury or death. Any modification will void the warranties and relieve Innopower Inc. from all liabilities. Failure to follow these instructions may result in serious injury or death!
-  **WARNING!** ALWAYS inspect the seat and all straps prior to each use. Replace the seat and/or any straps if inspection reveals any damage, including but not limited to wear, rot, fraying, deterioration and/or any other type of before each use. You must replace ALL straps (i.e., ratchet, cinch, tension, stabilizing straps/ropes, etc.) and suspension seats EVERY two (2) years. Inspect all tags and/or labels for dates prior to each use. If any tag or label is missing, damaged or unreadable, replace and do not use the strap. Use only Game Winner replacement straps. Use of any other straps, which are not genuine Game Winner straps constitutes a modification to the product and could result in serious injury or death. Any modification will void the warranties and relieve Game Winner from all liabilities. Failure to follow these instructions may result in serious injury or death!
-  **WARNING!** Replace full body harness every three years or sooner if wear, damage, deterioration, cuts, tears, rot, harness arrests fall, etc. are detected or suspected.
-  **WARNING!** Inspect all safety devices each time before each use. DO NOT use these devices if they show signs of wear, damage, deterioration, vandalism, fraying or other damage. Factors such as tree growth, vandals, weather and animals may affect the performance of an unattended treestand or safety device. Do not store these devices outdoors when not in use. Failure to follow these instructions may result in serious injury or death!
-  **WARNING!** NEVER adjust ANY straps, cables, and/or adjustable support bars while standing on treestand. Make all adjustments at ground level. DO NOT use any treestand if there is wear, rot, corrosion, cracks, fraying, deterioration and/or any other type of damage on any part of the treestand. Failure to follow these instructions may result in serious injury or death!

Store treestand and full body safety harnesses indoors in a clean, dry environment free from direct sunlight, harmful chemicals, excessive heat and dust. Exposure to sunlight, excessive heat and the elements can weaken tree strap or affect its performance.

Warranty Information

Important Warranty Information

Innopower Inc. warrants this Game Winner product against defect(s) in material and workmanship, under proper use and storage, for the period of one (1) year from the date of purchase. Proof of purchase, plus, the return of your warranty application card to our home office, is required for any warranty claim. In the events this product is found to be defective within the warranty period, Innopower Inc.'s only obligation and your exclusive remedy shall be replacement or repair of any defective parts at our discretion. To obtain warranty service, please contact Innopower Customer Service at (949) 262-3416. Exclusions to this warranty include seat, paint, plastics, webbing and/or defects caused by operator misuse and/or abuse. Limitation to liability include the forgoing warranty is made in lieu of all other warranties, express or implied and Innopower Inc. disclaims any implied warranty of merchantability and fitness. Innopower Inc. shall not be liable for any damages direct, consequential or incidental arising out of the use or inability of this product.

Warranty Application Card

I have read and understand the safety, assembly and operating instructions provided with my Game Winner product. I have read the warranty information and know that I can call Innopower Inc. at **(949) 262-3416** with any questions or concerns that I may have about this or any other Game Winner product. Mail to: INNOPOWER INC.

PO Box 265, E. Irvine, CA 92650. Email: customerservice@innopower.biz

Name _____ Purchase Location _____

Address _____

City/State/Zip _____

Purchase Date _____

Product _____

Manufactured by Innopower Inc., PO Box 265, E. Irvine, CA 92650