

NOTE:
Please read all instructions
carefully before using this
product

Safety Notice

Hardware Identifier

Assembly Instruction

Parts List

Warranty

Ordering Parts

Model
JD-3.1

Retain This
Manual for
Reference

4-30-05

**OWNER'S
MANUAL**

IMPEX

APEX JD-3.1 HYPER EXTENSION BENCH

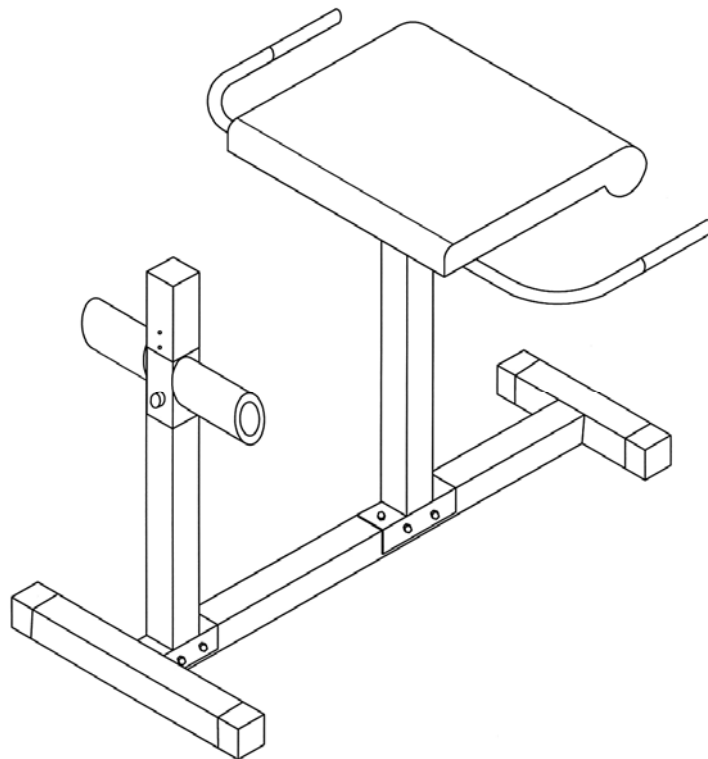

IMPEX INC.

2801 S. Towne Ave, Pomona, CA 91766

Tel: (800) 999-8899 Fax: (626) 961-9966

**www.impex-fitness.com
info@impex-fitness.com**

TABLE OF CONTENTS

BEFORE YOU BEGIN.....	1
IMPORTANT SAFETY NOTICES.....	2
HARDWARE PACK.....	3
ASSEMBLY INSTRUCTIONS.....	4
EXPLODED DIAGRAM.....	5
PARTS LIST.....	6
WARRANTY.....	7
ORDERING PARTS.....	7

BEFORE YOU BEGIN

Thank you for selecting the APEX JD-3.1 Hyper Extension Bench by IMPEX INC. For your safety and benefit, read this manual carefully before using the machine. As a manufacturer, we are committed to provide you complete customer satisfaction. If you have any questions, or find there are missing or damaged parts, we guarantee you complete satisfaction through direct assistance from our factory. To avoid unnecessary delays, *please call our TOLL-FREE customer service number.* Our Customer Service Agents will provide immediate assistance to you.

Toll-Free Customer Service Number

1-800-999-8899

Mon. - Fri. 9 a.m. - 5 p.m. PST

www.impex-fitness.com

info@impex-fitness.com

IMPORTANT SAFETY NOTICE

PRECAUTIONS

This exercise machine is built for optimum safety. However, certain precautions apply whenever you operate a piece of exercise equipment. Be sure to read the entire manual before you assemble or operate your machine. In particular, note the following safety precautions:

1. **Keep children and pets away from the machine at all times. DO NOT leave children unattended in the same room with the machine.**
2. Only one person at a time should use the machine.
3. If the user experiences dizziness, nausea, chest pain, or any other abnormal symptoms, STOP the workout at once. CONSULT A PHYSICIAN IMMEDIATELY.
4. Position the machine on a clear, leveled surface. DO NOT use the machine near water or outdoors.
5. Keep hands away from all moving parts.
6. Always wear appropriate workout clothing when exercising. DO NOT wear robes or other clothing that could become caught in the machine. Running or aerobic shoes are also required when using the machine.
7. Use the machine only for its intended use as described in this manual. DO NOT use attachments not recommended by the manufacturer.
8. Do not place any sharp object around the machine.
9. Disabled person should not use the machine without a qualified person or physician in attendance.
10. Before using the machine to exercise, always do stretching exercises to properly warm up.
11. Never operate the machine if the machine is not functioning properly.

WARNING: BEFORE BEGINNING ANY EXERCISE PROGRAM, CONSULT YOUR PHYSICIAN. THIS IS ESPECIALLY IMPORTANT FOR INDIVIDUALS OVER THE AGE OF 35 OR PERSONS WITH PRE-EXISTING HEALTH PROBLEMS. READ ALL INSTRUCTIONS BEFORE USING ANY FITNESS EQUIPMENT. IMPEX INC. ASSUMES NO RESPONSIBILITY FOR PERSONAL INJURY OR PROPERTY DAMAGE SUSTAINED BY OR THROUGH THE USE OF THIS PRODUCT.

SAVE THESE INSTRUCTIONS.

HARDWARE PACK

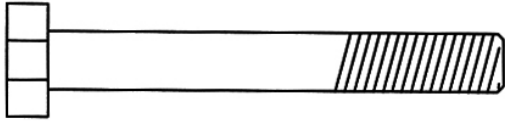

#12 M10 x 3" Hex Bolt (Qty 2)

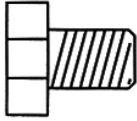

#11 M10 x $\frac{5}{8}$ " Hex Bolt (Qty 7)

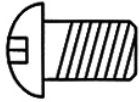

#16 M10 x $\frac{5}{8}$ " Allen Bolt (Qty 4)

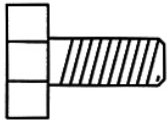

#13 M8 x $\frac{3}{4}$ " Hex Bolt (Qty 4)



#22 ϕ $\frac{3}{4}$ " Washer (Qty 15)



#14 ϕ $\frac{5}{8}$ " Washer (Qty 4)

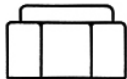

#15 M10 Aircraft Nut (Qty 2)

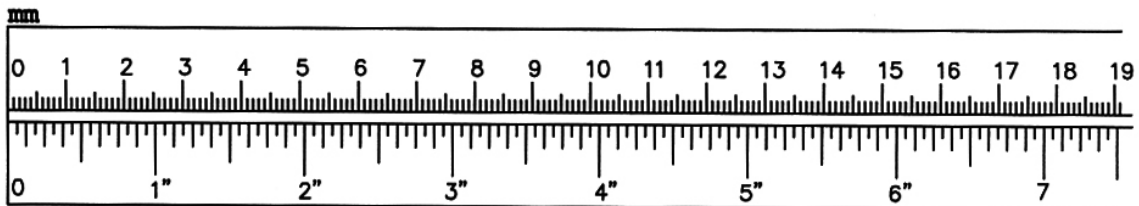

ASSEMBLY INSTRUCTION

Tools Required Assembling the Machine: Two Adjustable Wrenches and Allen Wrenches

NOTE: It is strongly recommended two or more people assembling this machine to avoid possible injury.

STEP 1 (See Exploded Diagram)

- A.) Insert the Rear Base Frame (#2) into the rear of Main Base Frame (#1). Attach the Rear Post (#3) to the Main Base Frame. Align the holes then secure them together with five M10 x 5/8" Hex Bolts (#11) and $\text{\O} \frac{3}{4}$ " Washers (#22).
- B.) Attach the Seat Post (#4) to the Main Base Frame (#1). Secure it with two M10 x 3" Hex Bolts (#12), four $\text{\O} \frac{3}{4}$ " Washers (#22), and two M10 Aircraft Nuts (#15) from the side. Secure it with two M10 x 5/8" Hex Bolts (#11), and $\text{\O} \frac{3}{4}$ " Washers (#22) from the top.
- C.) Attach the Seat Pad (#10) to the Seat Bracket (#6). Secure it with four M8 x $\frac{3}{4}$ " Hex Bolts (#13) and $\text{\O} \frac{5}{8}$ " Washers (#14).
- D.) Attach the Seat Bracket (#6) to the Seat Post (#4). Then attached the Left and Right Handlebars (#7) & (#8) to the Seat Post. Secure them with four M10 x 5/8" Allen Bolts (#16) and $\text{\O} \frac{3}{4}$ " Washers (#22).
- E.) Slide the Leg Support Frame (#5) onto the Rear Post. Use the Lock Knob (#9) to lock it at desired height.
- F.) Push two Foam Rolls (#17) onto the tube on the Leg Support Frame from both ends. Plug a Foam Roll End Cap (#18) to each Foam Roll.

EXPLODED DIAGRAM

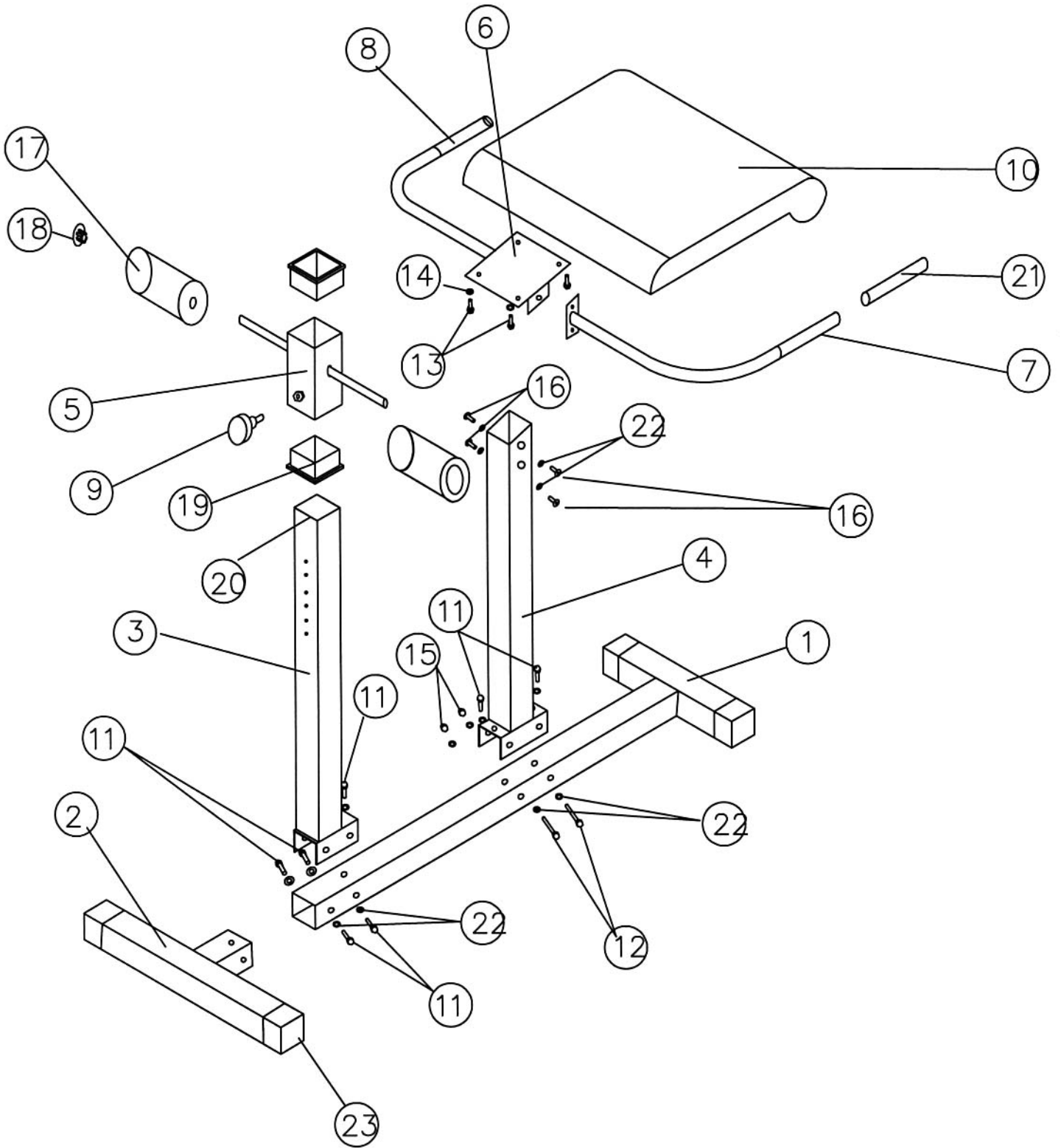

Parts list

KEY NO.	DESCRIPTION	Q'ty
1	Main Base Frame	1
2	Rear Base Frame	1
3	Rear Post	1
4	Seat Post	1
5	Leg Support Frame	1
6	Seat Bracket	1
7	Right Handle	1
8	Left Handle	1
9	Adjustment Knob	1
10	Seat Pad	1
11	M10 x 5/8" Hex Bolt	7
12	M10 x 3" Hex Bolt	2
13	M8 x 3/4" Hex Bolt	4
14	Ø 5/8" Washer	4
15	M10 Aircraft Nut	2
16	M10 x 5/8" Allen Bolt	4
17	Foam Roll	2
18	Foam Roll End Cap	2
19	3" x 2 3/8" Sleeve	2
20	2 3/8" End Cap	1
21	Handle Grip	2
22	Ø 3/4" Washer	15
23	2 3/8" Square End Cap	4

IMPEX INC.

LIMITED WARRANTY

IMPEX Inc. ("IMPEX") warrants this product to be free from defects in workmanship and material, under normal use and service conditions, for a period of two years on the Frame from the date of purchase. This warranty extends only to the original purchaser. IMPEX's obligation under this Warranty is limited to replacing or repairing, at IMPEX's option.

All returns must be pre-authorized by IMPEX. Pre-authorization may be obtained by calling IMPEX Customer Service Department at 1-800-999-8899. All freights on products returned to IMPEX must be prepaid by the customer. This warranty does not extend to any product or damage to a product caused by or attributable to freight damage, abuse, misuse, improper or abnormal usage or repairs not provided by an IMPEX authorized service center or for products used for commercial or rental purposes. No other warranty beyond that specifically set forth above is authorized by IMPEX.

IMPEX is not responsible or liable for indirect, special or consequential damages arising out of or in connection with the use or performance of the product or other damages with respect to any economic loss, loss of property, loss of revenues or profits, loss of enjoyments or use, costs of removal, installation or other consequential damages or whatsoever natures. Some states do not allow the exclusion or limitation of incidental or consequential damages. Accordingly, the above limitation may not apply to you.

The warranty extended hereunder is in lieu of any and all other warranties and any implied warranties of merchantability or fitness for a particular purpose is limited in its scope and duration to the terms set forth herein. Some states do not allow limitations on how long an implied warranty lasts. Accordingly, the above limitation may not apply to you.

This warranty gives you specific legal right. You may also have other rights which vary from state to state.

IMPEX INC.
2801 S. Towne Ave.
Pomona, CA 91766

ORDERING REPLACEMENT PARTS

Replacement parts can be ordered by calling our Customer Service Department toll-free at **1-800-999-8899** during our regular business hours: Monday through Friday, 9 am until 5 pm Pacific standard time.

www.impex-fitness.com
info@impex-fitness.com

When ordering replacement parts, always give the following information.

1. Model
2. Description of Parts
3. Part Number
4. Date of Purchase